



# **DREAM MOUNTAIN RANCH DISPERSAL SALE**

*January 15<sup>th</sup>, 2025*

**INNISFAIL AUCTION MART**

**1:00PM**



*We welcome you our 2025 herd dispersal sale, we feature some great Purebred and Commercial Black Angus Cattle. We have to offer 30 Purebred Black Angus and 14 Commercial Black Angus. We have been in the cattle business for over 33 years and due to health issues are forced to offer you our main breeding herd. We take pride in selecting cows and bulls with great temperaments and conformation.*

- ❖ *This year's calves are bred to **DMM FIRE 78H** is the son of the **2024 Reserve World Grand Champion Bull Brooking Firebrand 6068**.*
- ❖ *7 - 2024 Bull Calves, 8 – 2024 Heifer Calves, bred by **DMM Fire 78H***
- ❖ *4 Heifers, 23 – Young Cows*
- ❖ *1 – 2023 Breeding Bull, **2020 Herd Bull DMM Fire 78H***

*David Selinger 403-844-7374*

**No. 1**



- ❖ **OZS FIREBRAND 41M Bull Calf.**
- ❖ **The sire is DMM FIRE 78H, a son of Brooking Firebrand 6068.**
  - 🏠 CAA No. 2369905, APRIL 18, 2024
  - 🏠 BW = 96 lbs., WW = 624 lbs.
- ❖ A great herd sire prospect with thickness throughout, length and good temperament.
- ❖ This bull has great conformation, good feet.
- ❖ This bull has the potential to be as great as his grandfather. He exhibits all the quality features of a world-class competitor bull and is our overall best bull calf in 2024.

| World Angus Evaluation August 2024 Black Angus   |              |              |                |                 |       |       |               |          |       |       |                |          |       |        |     |                  |      |               |               |      |
|--|--------------|--------------|----------------|-----------------|-------|-------|---------------|----------|-------|-------|----------------|----------|-------|--------|-----|------------------|------|---------------|---------------|------|
|  | Calving Ease | Birth Weight | Weaning Weight | Yearling Weight | RADG  | DMI   | Scrotal Circ. | Docility | Claw  | Angle | Carcass Weight | Marbling | REA   | Fat    | HPG | Mat Calving Ease | Milk | Mature Weight | Mature Height | CBI  |
| EPD  | -6.0         | +5.4         | +59            | +100            | -     | -     | -             | -        | -     | -     | -              | -        | -     | -      | -   | +2.0             | +22  | -             | -             | -    |
| Accuracy   | 16           | 30           | 14             | 11              | -     | -     | -             | -        | -     | -     | -              | -        | -     | -      | -   | 9                | 9    | -             | -             | -    |
| TOP %  | 97           | 97           | 35             | 40              | -     | -     | -             | -        | -     | -     | -              | -        | -     | -      | -   | 92               | 65   | -             | -             | -    |
| Average EPDs for all Black Calves born in 2023 <a href="#">Click for Percentiles</a>               |              |              |                |                 |       |       |               |          |       |       |                |          |       |        |     |                  |      |               |               |      |
| EPD  | +3.3         | +2.0         | +54            | +95             | +0.24 | +0.91 | +0.85         | +18      | +0.44 | +0.45 | +43            | +0.47    | +0.53 | +0.021 | +11 | +6.6             | +23  | +61           | +0.4          | +285 |
| Average EPDs for all Red and Red Carrier Calves born in 2023 <a href="#">Click for Percentiles</a> |              |              |                |                 |       |       |               |          |       |       |                |          |       |        |     |                  |      |               |               |      |
| EPD  | +2.3         | +1.3         | +43            | +74             | +0.19 | +0.38 | +0.76         | +14      | +0.43 | +0.48 | +25            | +0.23    | +0.40 | -0.004 | +10 | +5.4             | +25  | +44           | +0.3          | +227 |

**Animal Enquiry**

Registration No. OZS FIREBRAND 41M (OZS 41M) 2369905  
 Rego Status Registered  
 LE Tattoo  
 Tattoo OZS 41M  
 Date of Birth 18 Apr 2024  
 Sire DMM FIRE 78H (DMM 78H) 2139847  
 Dam ABEL 4H (ABEL 4H) 2196203  
 Recipient Dam

- Details
- Pedigree
- Progeny
- EPDs
- Traits
- Ownership
- Breeder

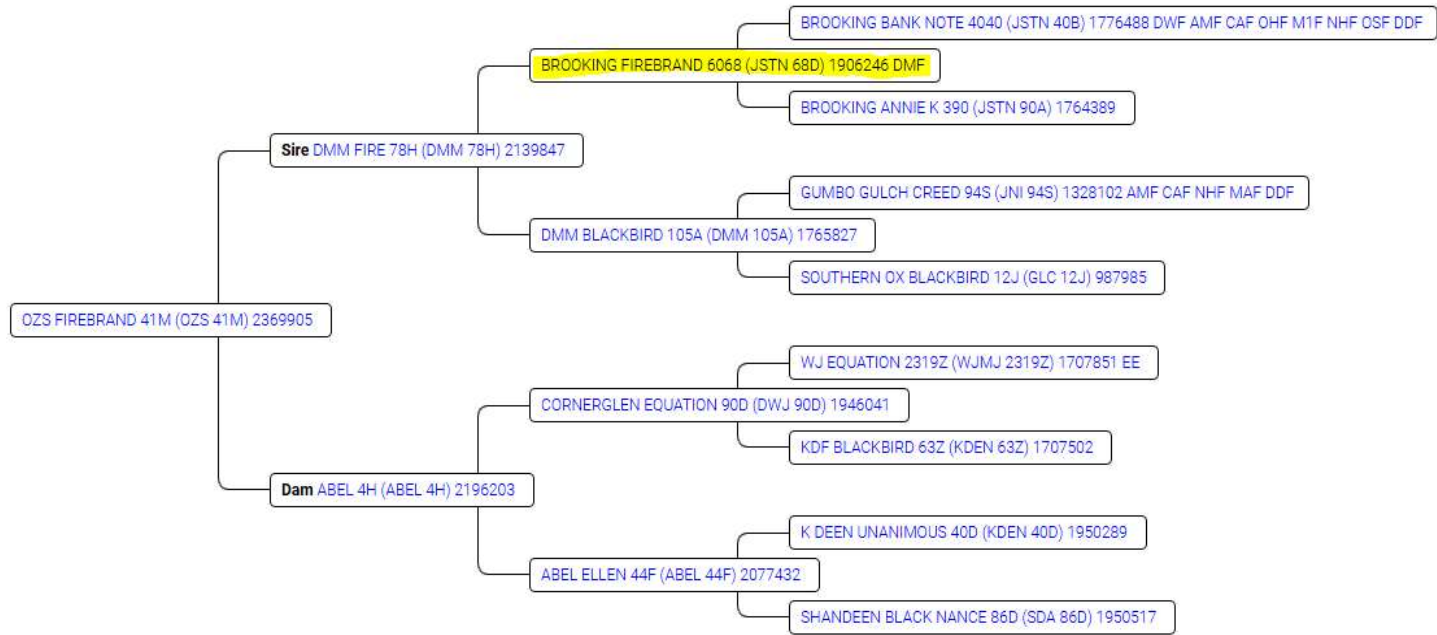

**No. 2**



- ❖ **OZS FIREBRAND 64M Bull Calf.**
- ❖ **The sire is DMM FIRE 78H, a son of Brooking Firebrand 6068.**
  - 🏠 CAA No. 2369908, APRIL 20, 2024
  - 🏠 BW = 70 lbs.
  - 🏠 WW = 502 lbs.
- ❖ This bull has great conformation. He will carry the size and muscle of his sire's genetics.
- ❖ He will make a great addition to any herd.

| World Angus Evaluation August 2024 Black Angus (Ped Est)   |              |              |                |                 |       |       |               |          |       |       |                |          |       |        |     |                  |      |               |               |      |
|--|--------------|--------------|----------------|-----------------|-------|-------|---------------|----------|-------|-------|----------------|----------|-------|--------|-----|------------------|------|---------------|---------------|------|
|  | Calving Ease | Birth Weight | Weaning Weight | Yearling Weight | RADG  | DMI   | Scrotal Circ. | Docility | Claw  | Angle | Carcass Weight | Marbling | REA   | Fat    | HPG | Mat Calving Ease | Milk | Mature Weight | Mature Height | CBI  |
| EPD  | -8.0         | +5.1         | +55            | +91             | -     | -     | -             | -        | -     | -     | -              | -        | -     | -      | -   | -3.5             | +20  | -             | -             | -    |
| Accuracy   | P            | P            | P              | P               | -     | -     | -             | -        | -     | -     | -              | -        | -     | -      | -   | P                | P    | -             | -             | -    |
| TOP %  | 98           | 96           | 45             | 55              | -     | -     | -             | -        | -     | -     | -              | -        | -     | -      | -   | 99               | 80   | -             | -             | -    |
| Average EPDs for all Black Calves born in 2023 <a href="#">Click for Percentiles</a>               |              |              |                |                 |       |       |               |          |       |       |                |          |       |        |     |                  |      |               |               |      |
| Average EPDs for all Red and Red Carrier Calves born in 2023 <a href="#">Click for Percentiles</a> |              |              |                |                 |       |       |               |          |       |       |                |          |       |        |     |                  |      |               |               |      |
| EPD  | +3.3         | +2.0         | +54            | +95             | +0.24 | +0.91 | +0.85         | +18      | +0.44 | +0.45 | +43            | +0.47    | +0.53 | +0.021 | +11 | +6.6             | +23  | +61           | +0.4          | +285 |
|  | +2.3         | +1.3         | +43            | +74             | +0.19 | +0.38 | +0.76         | +14      | +0.43 | +0.48 | +25            | +0.23    | +0.40 | -0.004 | +10 | +5.4             | +25  | +44           | +0.3          | +227 |

**Animal Enquiry**

Registration No. OZS FIREBRAND 64M (OZS 64M) 2369908  
 Rego Status Registered  
 LE Tattoo  
 Tattoo OZS 64M  
 Date of Birth 20 Apr 2024  
 Sire DMM FIRE 78H (DMM 78H) 2139847  
 Dam ABEL 63H (ABEL 63H) 2250541  
 Recipient Dam

- Details
- Pedigree
- Progeny
- EPDs
- Traits
- Ownership
- Breeder

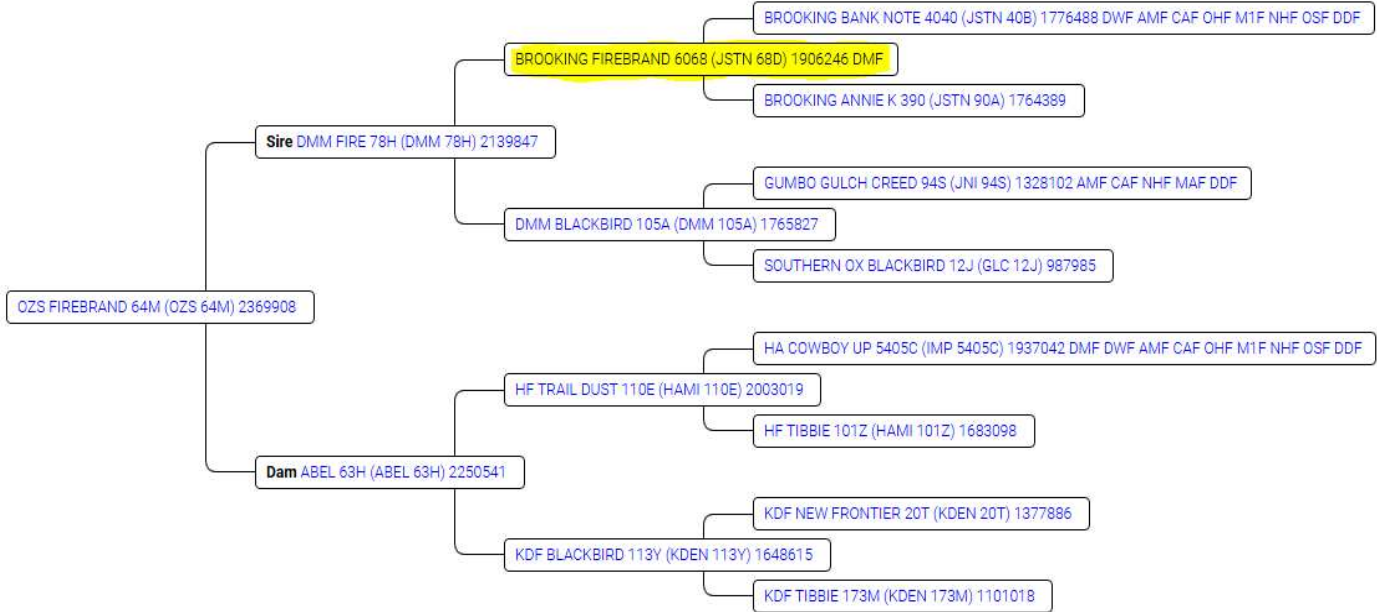

**No. 3**



- ❖ **OZS FIREBRAND 81M Bull Calf.**
- ❖ **The sire is DMM FIRE 78H, a son of Brooking Firebrand 6068.**
  - ✚ BD = APRIL 21, 2024
  - ✚ BW = 96 lbs.
  - ✚ WW = 528 lbs.
- ❖ This commercial bull is from a non-registered Dam with good conformation, depth and length.
- ❖ His dam was our lead cow for many years.
- ❖ The dam originated from purebred stock but unfortunately was not registered.

| #   | CED        | BW      | W<br>W | YW | SCTOTAL |
|-----|------------|---------|--------|----|---------|
| EPD | -          | 96 lbs. |        |    |         |
| ACC | -          | -       | -      | -  |         |
| EPD | -          | -       | -      | -  |         |
| BD  | 04/21/2024 |         |        |    |         |

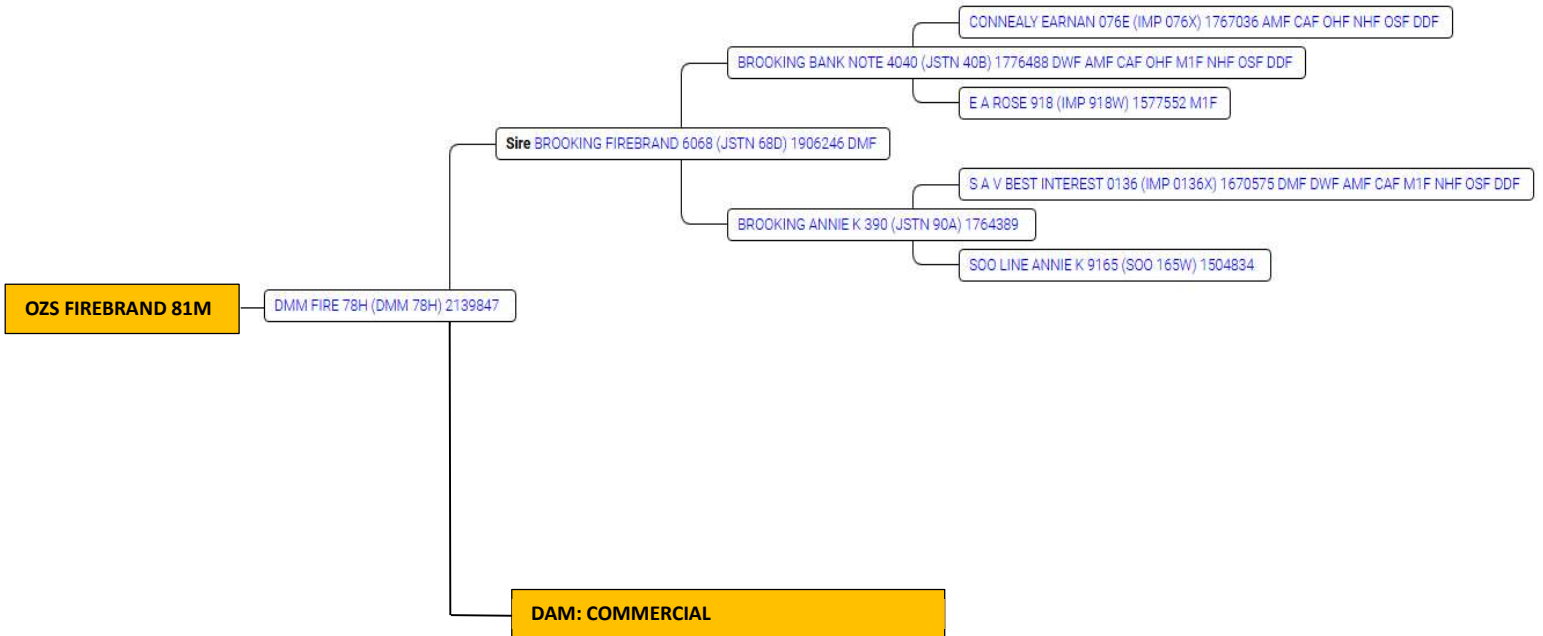

**No. 4**



- ❖ **OZS FIREBRAND 52M Bull Calf.**
- ❖ **The sire is DMM FIRE 78H, a son of Brooking Firebrand 6068.**
  - 📍 CAA No. 2372034, APRIL 23, 2024
  - 📍 BW = 94 lbs. WW = 546 lbs.
- ❖ Attractive, well-balanced bull with impressive conformation, depth, and good length. This bull is full of potential to become something great.
- ❖ Dam has great temperament, is very curious and quiet.

| World Angus Evaluation August 2024 Black Angus   |              |              |                |                 |       |       |               |          |       |       |                |          |       |        |     |                  |      |               |               |      |
|--|--------------|--------------|----------------|-----------------|-------|-------|---------------|----------|-------|-------|----------------|----------|-------|--------|-----|------------------|------|---------------|---------------|------|
|  | Calving Ease | Birth Weight | Weaning Weight | Yearling Weight | RADG  | DMI   | Scrotal Circ. | Docility | Claw  | Angle | Carcass Weight | Marbling | REA   | Fat    | HPG | Mat Calving Ease | Milk | Mature Weight | Mature Height | CBI  |
| EPD  | -3.0         | +4.7         | +51            | +89             | -     | -     | -             | -        | -     | -     | -              | -        | -     | -      | -   | +4.0             | +21  | -             | -             | -    |
| Accuracy   | 16           | 30           | 14             | 12              | -     | -     | -             | -        | -     | -     | -              | -        | -     | -      | -   | 9                | 9    | -             | -             | -    |
| TOP %  | 92           | 94           | 60             | 60              | -     | -     | -             | -        | -     | -     | -              | -        | -     | -      | -   | 80               | 75   | -             | -             | -    |
| Average EPDs for all Black Calves born in 2023 <a href="#">Click for Percentiles</a>               |              |              |                |                 |       |       |               |          |       |       |                |          |       |        |     |                  |      |               |               |      |
| Average EPDs for all Red and Red Carrier Calves born in 2023 <a href="#">Click for Percentiles</a> |              |              |                |                 |       |       |               |          |       |       |                |          |       |        |     |                  |      |               |               |      |
| EPD  | +3.3         | +2.0         | +54            | +95             | +0.24 | +0.91 | +0.85         | +18      | +0.44 | +0.45 | +43            | +0.47    | +0.53 | +0.021 | +11 | +6.6             | +23  | +61           | +0.4          | +285 |
|  | +2.3         | +1.3         | +43            | +74             | +0.19 | +0.38 | +0.76         | +14      | +0.43 | +0.48 | +25            | +0.23    | +0.40 | -0.004 | +10 | +5.4             | +25  | +44           | +0.3          | +227 |

**Animal Enquiry**

Registration No. OZS FIREBRAND 52M (OZS 52M) 2372034  
 Rego Status Registered  
 LE Tattoo  
 Tattoo OZS 52M  
 Date of Birth 23 Apr 2024  
 Sire DMM FIRE 78H (DMM 78H) 2139847  
 Dam ABEL 52H (ABEL 52H) 2224542  
 Recipient Dam

- Details
- Pedigree
- Progeny
- EPDs
- Traits
- Ownership
- Breeder

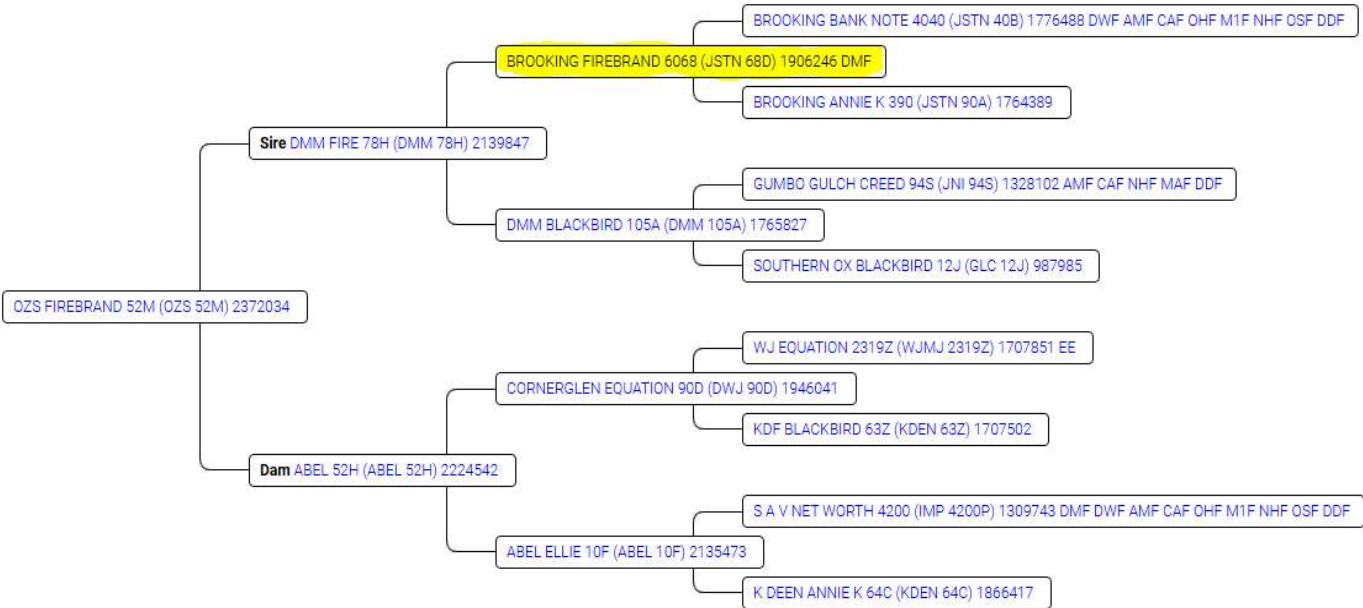

**No. 5**



- ❖ **OZS FIREBRAND 80M Bull Calf.**
- ❖ **The sire is DMM FIRE 78H, a son of Brooking Firebrand 6068.**
  - ✚ BD = APRIL 30, 2024
  - ✚ BW = 110 lbs.
  - ✚ WW = 576 lbs.
- ❖ We have had this bull's commercial line for +20 yrs.
- ❖ His dam's side has incredible feet, udder and maternal characteristics. She's a very easy calver.
- ❖ Proven calving ease bull that carries plenty of performance.
- ❖ Feet are exceptional in this line of bulls.

| #   | CED        | BW       | WW | YW | SCTOTAL |
|-----|------------|----------|----|----|---------|
| EPD | -          | 110 lbs. |    |    |         |
| ACC | -          | -        | -  | -  |         |
|     |            |          |    |    |         |
| EPD | -          | -        | -  | -  |         |
| BD  | 04/30/2024 |          |    |    |         |

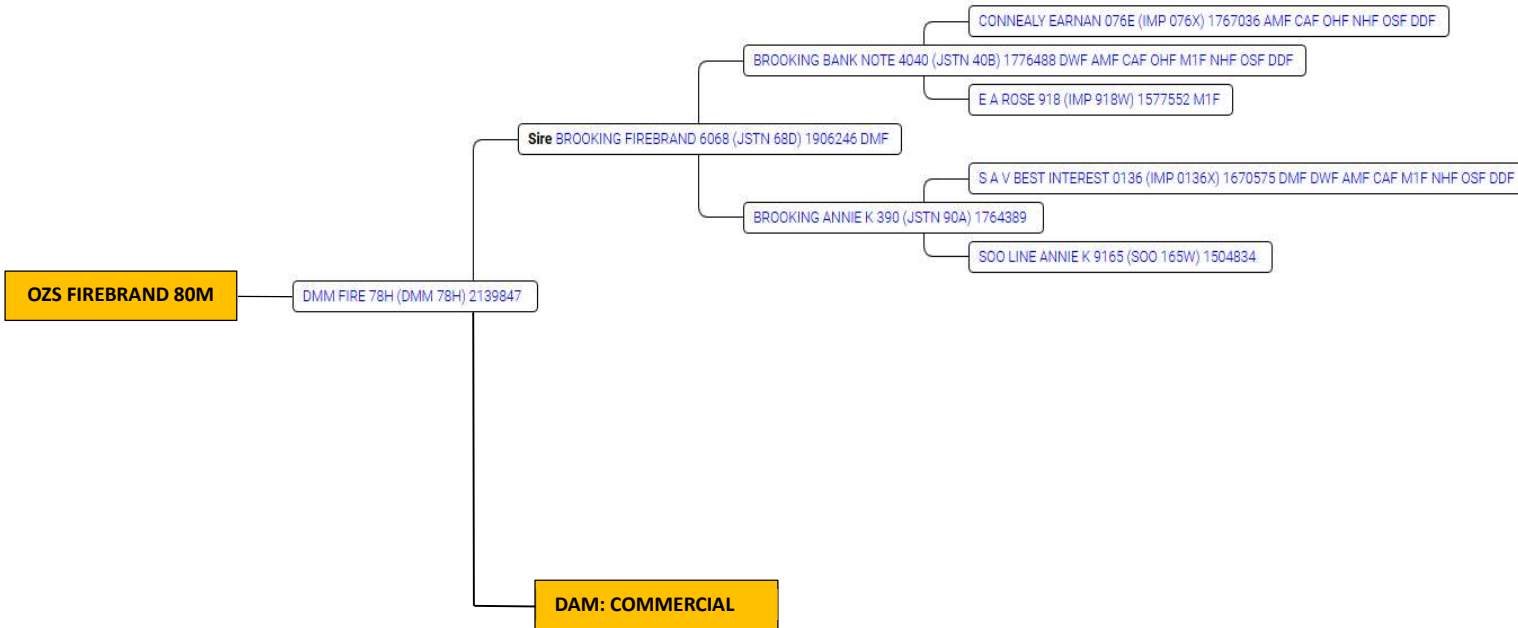

**No. 6**



- ❖ **OZS FIREBRAND 3M Bull Calf.**
- ❖ **The sire is DMM FIRE 78H, a son of Brooking Firebrand 6068.**
  - ⊕ BD = MAY 24, 2024
  - ⊕ BW = 96 lbs.
  - ⊕ WW = 456 lbs.
- ❖ Top end commercial line, non-registered with CAA but from purebred stock.
- ❖ Good looking young bull that will mature with the same astounding stature as his sire.

| #   | CED        | BW      | WW | YW | SCTOTAL |
|-----|------------|---------|----|----|---------|
| EPD | -          | 96 lbs. |    |    |         |
| ACC | -          | -       | -  | -  |         |
| EPD | -          | -       | -  | -  |         |
| BD  | 05/24/2024 |         |    |    |         |

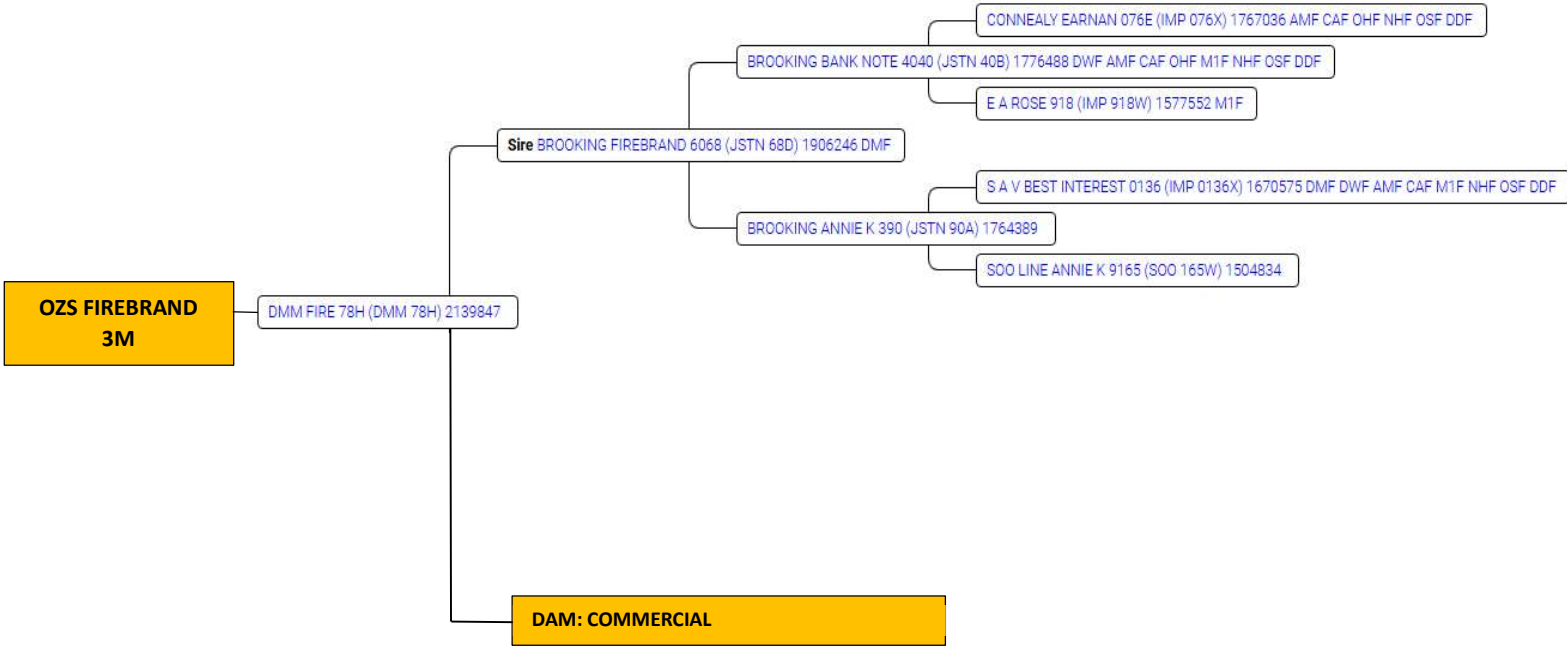

No. 7



- ❖ OZS FIREBRAND 18M Bull Calf.
- ❖ The sire is DMM FIRE 78H, a son of Brooking Firebrand 6068.
  - 🇺🇸 CAA No. 2372035, MAY 17, 2024
  - 🇺🇸 BW = 78 lbs. WW = 488 lbs.
- ❖ This is a well-built young bull, that would be a great addition to your herd.
- ❖ We really like the conformation of this young bull. He will add great performance into your herd.
- ❖ His dam follows the legacy Tibbie Genetic line.

| World Angus Evaluation August 2024 Black Angus   |              |              |                |                 |       |       |               |          |       |       |                |          |       |        |     |                  |      |               |               |      |
|--|--------------|--------------|----------------|-----------------|-------|-------|---------------|----------|-------|-------|----------------|----------|-------|--------|-----|------------------|------|---------------|---------------|------|
|  | Calving Ease | Birth Weight | Weaning Weight | Yearling Weight | RADG  | DMI   | Scrotal Circ. | Docility | Claw  | Angle | Carcass Weight | Marbling | REA   | Fat    | HPG | Mat Calving Ease | Milk | Mature Weight | Mature Height | CBI  |
| EPD  | +2.0         | +2.4         | +47            | +78             | -     | -     | -             | -        | -     | -     | -              | -        | -     | -      | -   | +4.0             | +20  | -             | -             | -    |
| Accuracy   | 15           | 30           | 14             | 10              | -     | -     | -             | -        | -     | -     | -              | -        | -     | -      | -   | 9                | 9    | -             | -             | -    |
| TOP %  | 65           | 55           | 70             | 80              | -     | -     | -             | -        | -     | -     | -              | -        | -     | -      | -   | 80               | 80   | -             | -             | -    |
| Average EPDs for all Black Calves born in 2023 <a href="#">Click for Percentiles</a>               |              |              |                |                 |       |       |               |          |       |       |                |          |       |        |     |                  |      |               |               |      |
| Average EPDs for all Red and Red Carrier Calves born in 2023 <a href="#">Click for Percentiles</a> |              |              |                |                 |       |       |               |          |       |       |                |          |       |        |     |                  |      |               |               |      |
| EPD  | +3.3         | +2.0         | +54            | +95             | +0.24 | +0.91 | +0.85         | +18      | +0.44 | +0.45 | +43            | +0.47    | +0.53 | +0.021 | +11 | +6.6             | +23  | +61           | +0.4          | +285 |
|  | +2.3         | +1.3         | +43            | +74             | +0.19 | +0.38 | +0.76         | +14      | +0.43 | +0.48 | +25            | +0.23    | +0.40 | -0.004 | +10 | +5.4             | +25  | +44           | +0.3          | +227 |

Animal Enquiry

Registration No. OZS FIREBRAND 18M (OZS 18M) 2372035  
 Rego Status Registered  
 LE Tattoo  
 Tattoo OZS 18M  
 Date of Birth 17 May 2024  
 Sire DMM FIRE 78H (DMM 78H) 2139847  
 Dam ABEL TIBBIE 18J (ABEL 18J) 2240979  
 Recipient Dam

- Details
- Pedigree**
- Progeny
- EPDs
- Traits
- Ownership
- Breeder

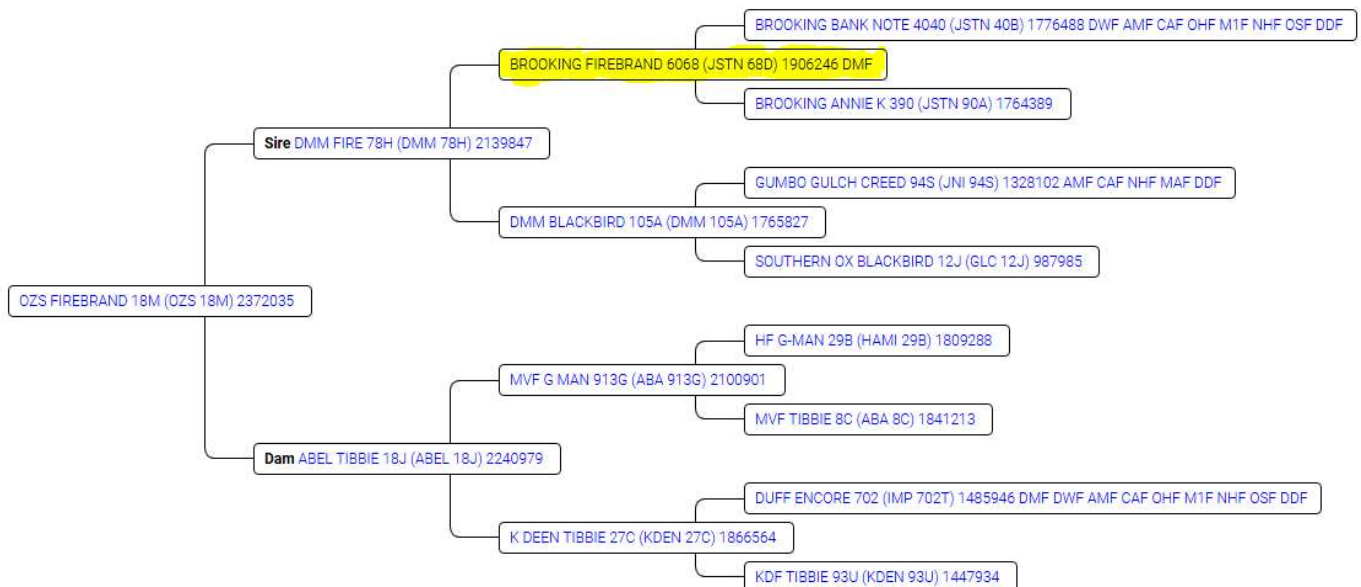



**No. 8**



- ❖ **OZS FIREBRAND 6M Heifer Calf.**
- ❖ **The sire is DMM FIRE 78H, a son of Brooking Firebrand 6068.**
  - ✚ BD = APRIL 11, 2024
  - ✚ BW = 84 lbs.
  - ✚ WW = 528 lbs.
- ❖ This is a top end commercial line, non-registered with CAA but from purebred stock.
- ❖ We love the confirmation of this heifer's dam, she's very well built with a great udder. We give her high marks on calving ease.

| #   | CED        | BW      | WW | YW | MIK |
|-----|------------|---------|----|----|-----|
| EPD | -          | 84 lbs. |    |    |     |
| ACC | -          | -       | -  | -  |     |
|     |            |         |    |    |     |
| EPD | -          | -       | -  | -  |     |
| BD  | 04/11/2024 |         |    |    |     |

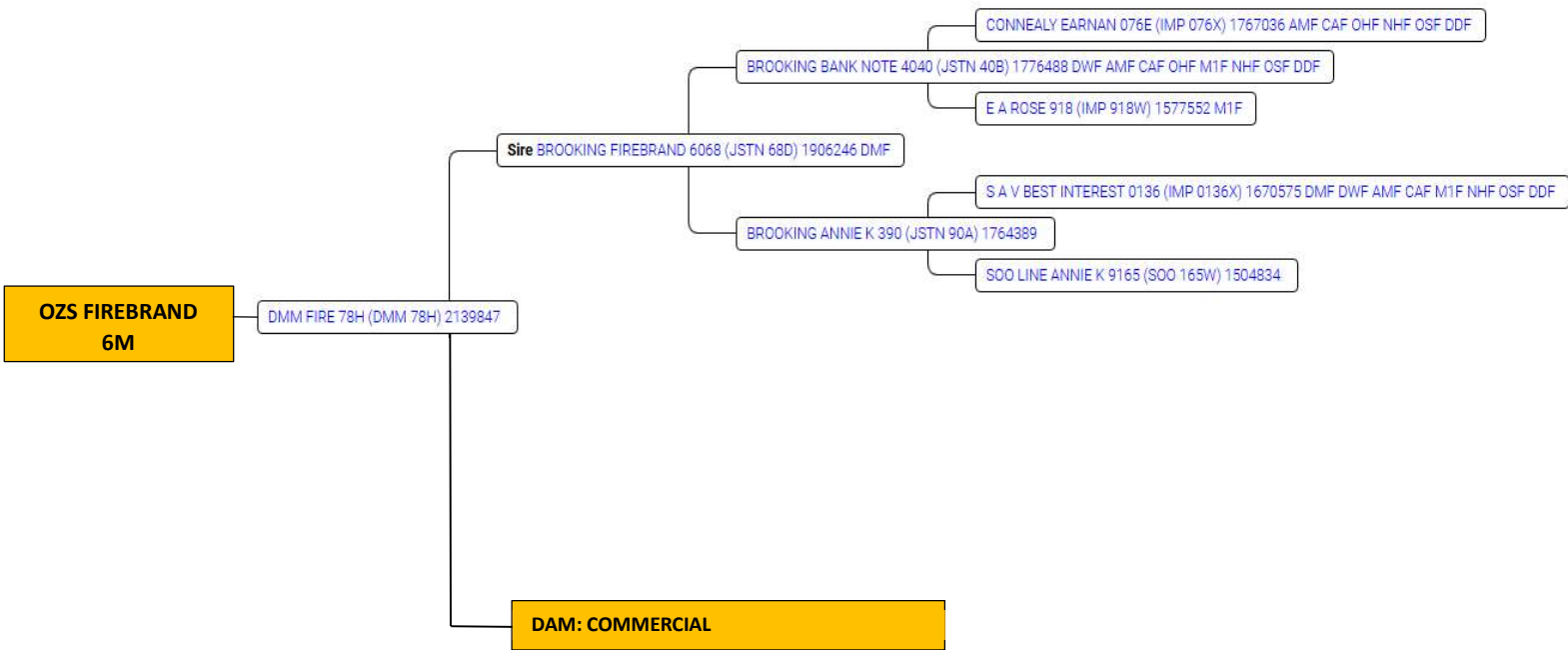

**No. 9**



- ❖ **OZS FIREBRAND 23M Heifer Calf.**
- ❖ **The sire is DMM FIRE 78H, a son of Brooking Firebrand 6068.**
  - ✚ BD = APRIL 11, 2024
  - ✚ BW = 94 lbs.
  - ✚ WW = 590 lbs.
- ❖ This is a top end commercial line, non-registered with CAA but from purebred stock.
- ❖ We really love this heifer. She's very curious and friendly and loves to follow you around.
- ❖ This heifer has all the qualities to be amazing performer.
- ❖ Dam is an easy calver, with great udder and maternal qualities.

| #   | CED        | BW      | WW | YW | MIK |
|-----|------------|---------|----|----|-----|
| EPD | -          | 94 lbs. |    |    |     |
| ACC | -          | -       | -  | -  |     |
| EPD | -          | -       | -  | -  |     |
| BD  | 04/11/2024 |         |    |    |     |

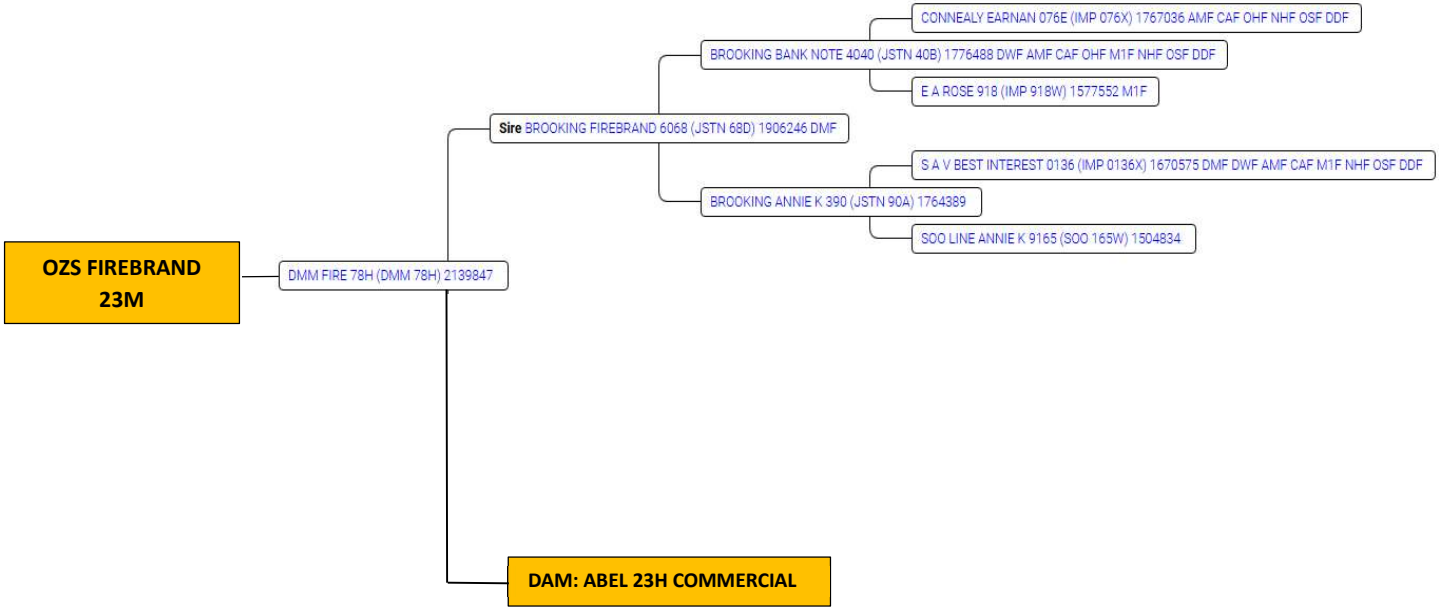

**No. 10**



- ❖ **OZS FIREBRAND 82M Heifer Calf.**
- ❖ **The sire is DMM FIRE 78H, a son of Brooking Firebrand 6068.**
  - 📅 BD = APRIL 26, 2024
  - 📊 BW = 94 lbs.
  - 📊 WW = 556 lbs.
- ❖ This is a top end commercial line, non-registered with CAA but from purebred stock.
- ❖ This is a very quiet heifer calf.
- ❖ Dam is very quiet and with ease of calving. Produces great calves year after year.

| #   | CED        | BW      | WW | YW | MIK |
|-----|------------|---------|----|----|-----|
| EPD | -          | 94 lbs. |    |    |     |
| ACC | -          | -       | -  | -  |     |
| EPD | -          | -       | -  | -  |     |
| BD  | 04/26/2024 |         |    |    |     |

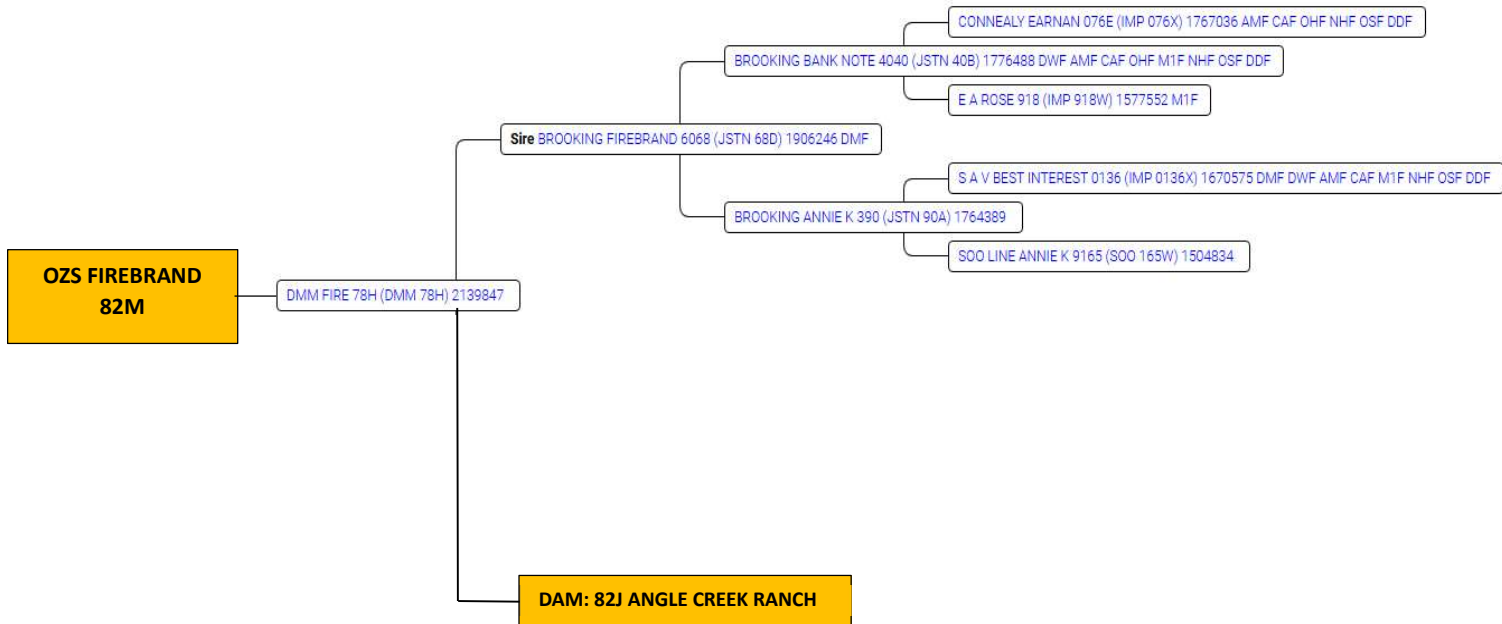

# No. 11



- ❖ **OZS FORD 4M Heifer Calf.**
- ❖ **The sire is DMM FIRE 78H, a son of Brooking Firebrand 6068.**

- 🇺🇸 CAA No. 2372040, APRIL 12, 2024
- 🇺🇸 BW = 78 lbs.
- 🇺🇸 WW = 506 lbs.

- ❖ This is a well-built young heifer, would be a great addition to your herd.
- ❖ The dam is very quiet and calves easily.
- ❖ This heifer will have world class characteristics with easy calving and amazing conformation for years to come.
- ❖ Dam **Selinger OZS 4K**

| #  | CED  | BW   | WW   | YW   | RADG  | DMI   | Scrotal | DOC  | Claw  | Angle | CWT  | Marble | REA   | Fat    | HPG  | CEM  | Milk | MW   | MH   | CBI  |
|--|------|------|------|------|-------|-------|---------|------|-------|-------|------|--------|-------|--------|------|------|------|------|------|------|
| EPD  | -1.0 | +2.1 | +49  | +81  |       |       |         |      |       |       |      |        |       |        |      | +3.0 | +24  |      |      |      |
| ACC  | 18   | 30   | 16   | 10   |       |       |         |      |       |       |      |        |       |        |      | 8    | 7    |      |      |      |
| Breed Avg (Click for Percentiles)                |      |      |      |      |       |       |         |      |       |       |      |        |       |        |      |      |      |      |      |      |
| EPD  | +3.3 | +2.0 | +54  | +95  | +0.24 | +0.91 | +0.86   | +18  | +0.44 | +0.45 | +43  | +0.47  | +0.53 | +0.020 | +11  | +6.4 | +23  | +61  | +0.4 | +285 |
| EPD Percentiles for OZS FORD 4M (OZS 4M) 2372040 |      |      |      |      |       |       |         |      |       |       |      |        |       |        |      |      |      |      |      |      |
|  | 80 % | 50 % | 66 % | 76 % | 50 %  | 50 %  | 50 %    | 50 % | 50 %  | 50 %  | 50 % | 50 %   | 50 %  | 50 %   | 50 % | 82 % | 39 % | 50 % | 50 % | 50 % |

## Animal Enquiry

**Registration No.** OZS FORD 4M (OZS 4M) 2372040  
**Rego Status** Registered  
**LE Tattoo**  
**Tattoo** OZS 4M  
**Date of Birth** 12 Apr 2024  
**Sire** DMM FIRE 78H (DMM 78H) 2139847  
**Dam** SELINGER OZS 4K (OZS 4K) 2290395  
**Recipient Dam**

- Details
- Pedigree**
- Progeny
- EPDs
- Traits
- Ownership
- Breeder

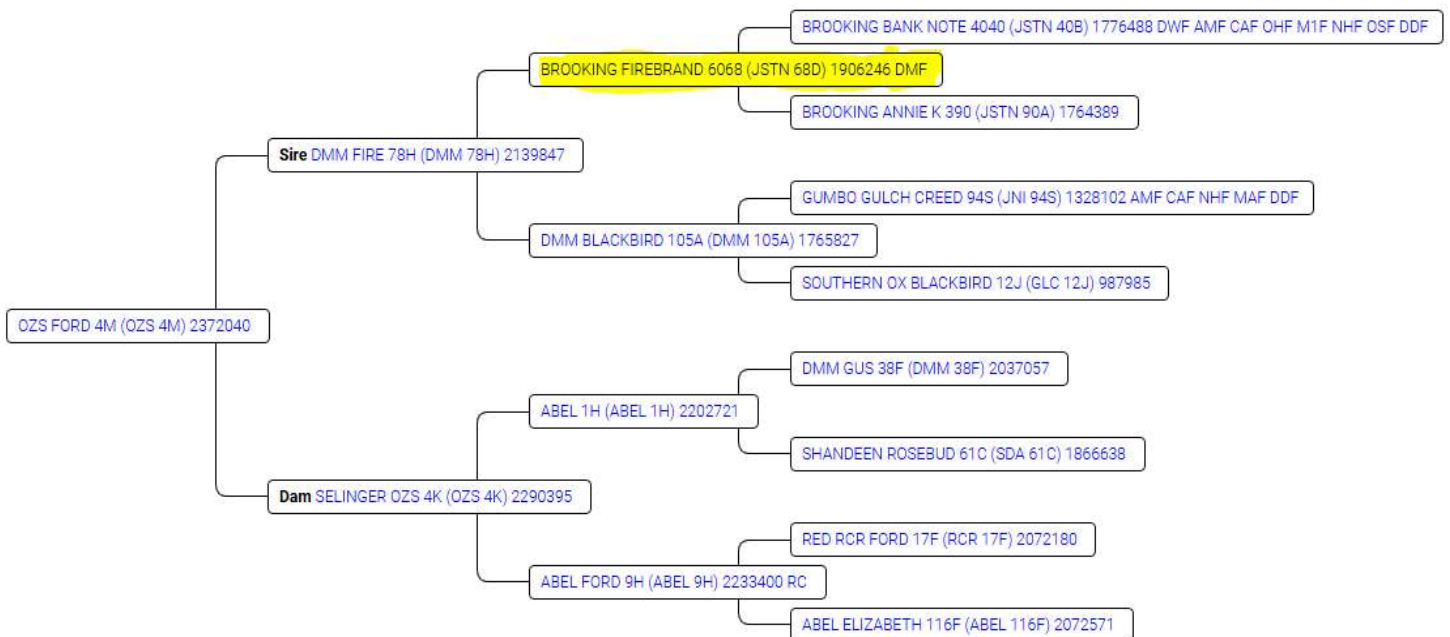

**No. 12**



- ❖ **OZS EBONI 16M Heifer Calf.**
- ❖ **The sire is DMM FIRE 78H, a son of Brooking Firebrand 6068.**
  - 🇺🇸 CAA No. 2372039, MAY 01, 2024
  - 🇺🇸 BW = 94 lbs.
  - 🇺🇸 WW = 516 lbs.
- ❖ This is a well-built young heifer.
- ❖ She will add exceptional ease of calving and confirmation to your herd.

| #   | CED  | BW   | WW   | YW   | RADG  | DMI   | Scrotal | DOC  | Claw  | Angle | CWT  | Marble | REA   | Fat    | HPG  | CEM  | Milk | MW   | MH   | CBI  |
|---|------|------|------|------|-------|-------|---------|------|-------|-------|------|--------|-------|--------|------|------|------|------|------|------|
| EPD   | -4.0 | +3.8 | +59  | +99  |       |       |         |      |       |       |      |        |       |        |      | +3.0 | +23  |      |      |      |
| ACC   | 16   | 31   | 17   | 13   |       |       |         |      |       |       |      |        |       |        |      | 9    | 9    |      |      |      |
| Breed Avg (Click for Percentiles)                   |      |      |      |      |       |       |         |      |       |       |      |        |       |        |      |      |      |      |      |      |
| EPD   | +3.3 | +2.0 | +54  | +95  | +0.24 | +0.91 | +0.86   | +18  | +0.44 | +0.45 | +43  | +0.47  | +0.53 | +0.020 | +11  | +6.4 | +23  | +61  | +0.4 | +285 |
| EPD Percentiles for OZS EBONI 16M (OZS 16M) 2372039 |      |      |      |      |       |       |         |      |       |       |      |        |       |        |      |      |      |      |      |      |
|   | 93 % | 85 % | 33 % | 42 % | 50 %  | 50 %  | 50 %    | 50 % | 50 %  | 50 %  | 50 % | 50 %   | 50 %  | 50 %   | 50 % | 82 % | 49 % | 50 % | 50 % | 50 % |

**Animal Enquiry**

**Registration No.** OZS EBONI 16M (OZS 16M) 2372039  
**Rego Status** Registered  
**LE Tattoo**  
**Tattoo** OZS 16M  
**Date of Birth** 01 May 2024  
**Sire** DMM FIRE 78H (DMM 78H) 2139847  
**Dam** ABEL EBONI 16H (ABEL 16H) 2241268  
**Recipient Dam**

- Details
- Pedigree**
- Progeny
- EPDs
- Traits
- Ownership
- Breeder

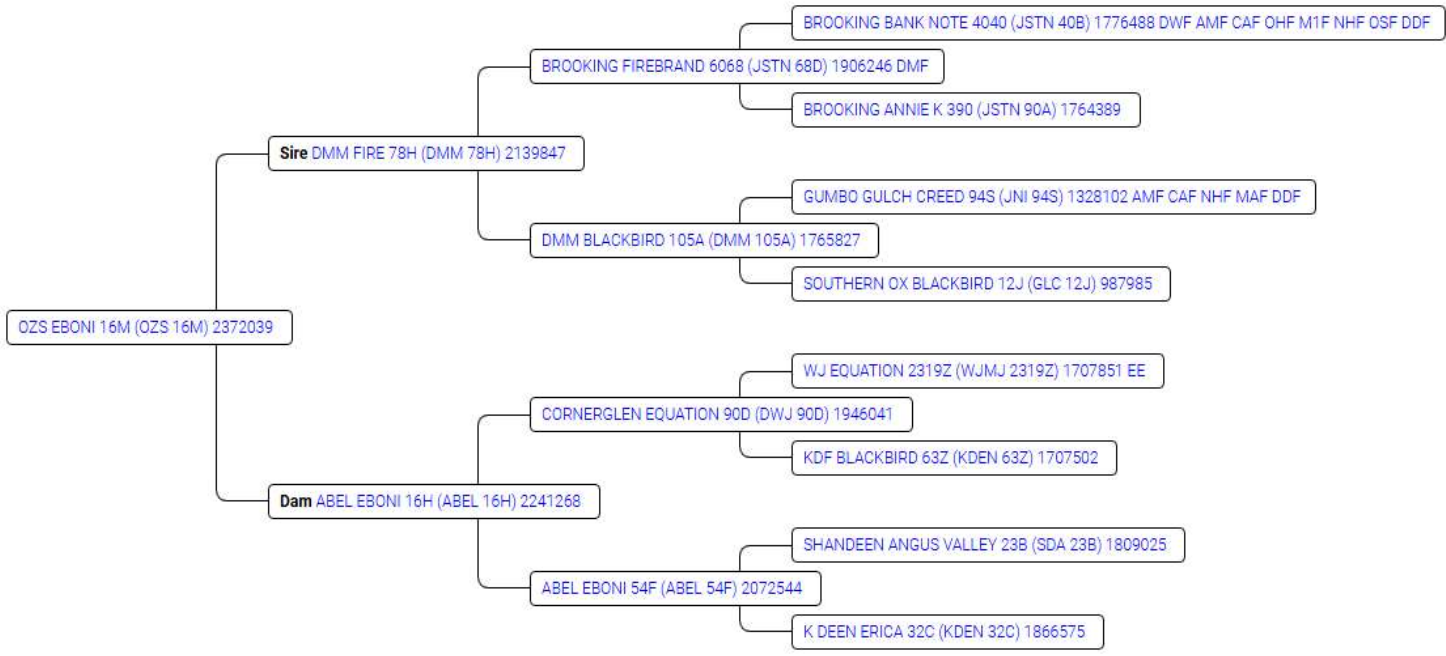

**No. 13**



- ❖ **OZS BLACKBIRD 61M Heifer Calf.**
- ❖ **The sire is DMM FIRE 78H, a son of Brooking Firebrand 6068.**
  - 🇺🇸 CAA No. 2372042, MAY 03,2024
  - 🇺🇸 BW = 95 lbs.
  - 🇺🇸 WW = 490 lbs.
- ❖ This is a very well-built young heifer.
- ❖ She has legacy Blackbird genetic lines on both sides, for improving performance in your herd.
- ❖ Dam No. **Selinger OZS 6K**

| #   | CED   | BW   | WW   | YW   | RADG  | DMI   | Scrotal | DOC  | Claw  | Angle | CWT  | Marble | REA   | Fat    | HPG  | CEM   | Milk | MW   | MH   | CBI  |
|---|-------|------|------|------|-------|-------|---------|------|-------|-------|------|--------|-------|--------|------|-------|------|------|------|------|
| EPD   | -12.0 | +5.0 | +55  | +93  |       |       |         |      |       |       |      |        |       |        |      | -6.0  | +22  |      |      |      |
| ACC   | 18    | 30   | 15   | 10   |       |       |         |      |       |       |      |        |       |        |      | 8     | 7    |      |      |      |
| Breed Avg (Click for Percentiles)                       |       |      |      |      |       |       |         |      |       |       |      |        |       |        |      |       |      |      |      |      |
| EPD   | +3.3  | +2.0 | +54  | +95  | +0.24 | +0.91 | +0.86   | +18  | +0.44 | +0.45 | +43  | +0.47  | +0.53 | +0.020 | +11  | +6.4  | +23  | +61  | +0.4 | +285 |
| EPD Percentiles for OZS BLACKBIRD 61M (OZS 61M) 2372042 |       |      |      |      |       |       |         |      |       |       |      |        |       |        |      |       |      |      |      |      |
|   | 100 % | 96 % | 46 % | 54 % | 50 %  | 50 %  | 50 %    | 50 % | 50 %  | 50 %  | 50 % | 50 %   | 50 %  | 50 %   | 50 % | 100 % | 58 % | 50 % | 50 % | 50 % |

**Animal Enquiry**

**Registration No.** OZS BLACKBIRD 61M (OZS 61M) 2372042  
**Rego Status** Registered  
**LE Tattoo**  
**Tattoo** OZS 61M  
**Date of Birth** 03 May 2024  
**Sire** DMM FIRE 78H (DMM 78H) 2139847  
**Dam** SELINGER OZS 6K (OZS 6K) 2290433  
**Recipient Dam**

- Details
- Pedigree
- Progeny
- EPDs
- Traits
- Ownership
- Breeder

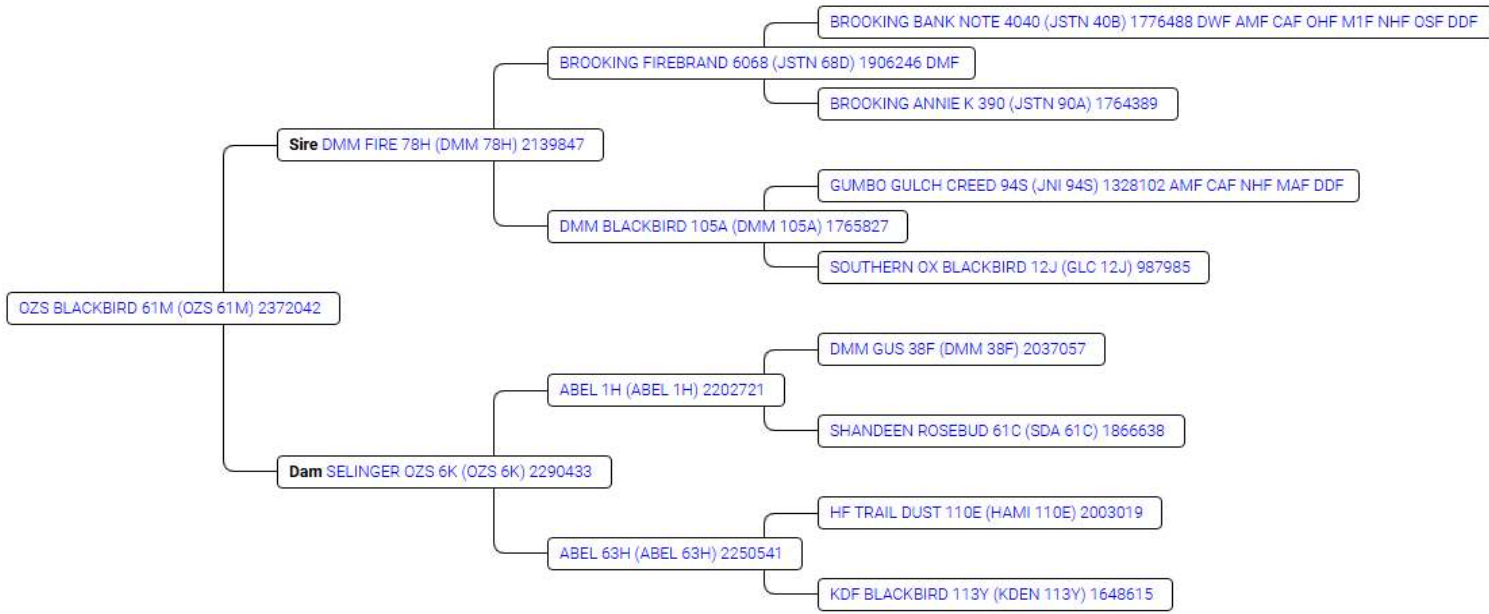

**No. 14**



- ❖ **OZS ELIZABETH 9M Heifer Calf,**
- ❖ **The sire is DMM FIRE 78H, a son of Brooking Firebrand 6068.**
  - 🏆 CAA No. 2372037, MAY 10, 2024
  - 🏆 BW = 93 lbs.
  - 🏆 WW = 528 lbs.
- ❖ Here is an upcoming heifer with excellent genetic lines top and bottom, featuring top performers and strong maternal characteristics.

| #   | CED  | BW   | WW   | YW   | RADG  | DMI   | Scrotal | DOC  | Claw  | Angle | CWT  | Marble | REA   | Fat    | HPG  | CEM  | Milk | MW   | MH   | CBI  |
|---|------|------|------|------|-------|-------|---------|------|-------|-------|------|--------|-------|--------|------|------|------|------|------|------|
| EPD   | -5.0 | +4.1 | +52  | +85  |       |       |         |      |       |       |      |        |       |        |      | +2.0 | +24  |      |      |      |
| ACC   | 17   | 31   | 17   | 13   |       |       |         |      |       |       |      |        |       |        |      | 9    | 9    |      |      |      |
| Breed Avg (Click for Percentiles)                     |      |      |      |      |       |       |         |      |       |       |      |        |       |        |      |      |      |      |      |      |
| EPD   | +3.3 | +2.0 | +54  | +95  | +0.24 | +0.91 | +0.86   | +18  | +0.44 | +0.45 | +43  | +0.47  | +0.53 | +0.020 | +11  | +6.4 | +23  | +61  | +0.4 | +285 |
| EPD Percentiles for OZS ELIZABETH 9M (OZS 9M) 2372037 |      |      |      |      |       |       |         |      |       |       |      |        |       |        |      |      |      |      |      |      |
|   | 95 % | 89 % | 56 % | 69 % | 50 %  | 50 %  | 50 %    | 50 % | 50 %  | 50 %  | 50 % | 50 %   | 50 %  | 50 %   | 50 % | 88 % | 39 % | 50 % | 50 % | 50 % |

**Animal Enquiry**

**Registration No.** OZS ELIZABETH 9M (OZS 9M) 2372037  
**Rego Status** Registered  
**LE Tattoo**  
**Tattoo** OZS 9M  
**Date of Birth** 10 May 2024  
**Sire** DMM FIRE 78H (DMM 78H) 2139847  
**Dam** ABEL FORD 9H (ABEL 9H) 2233400 RC  
**Recipient Dam**

- Details
- Pedigree**
- Progeny
- EPDs
- Traits
- Ownership
- Breeder

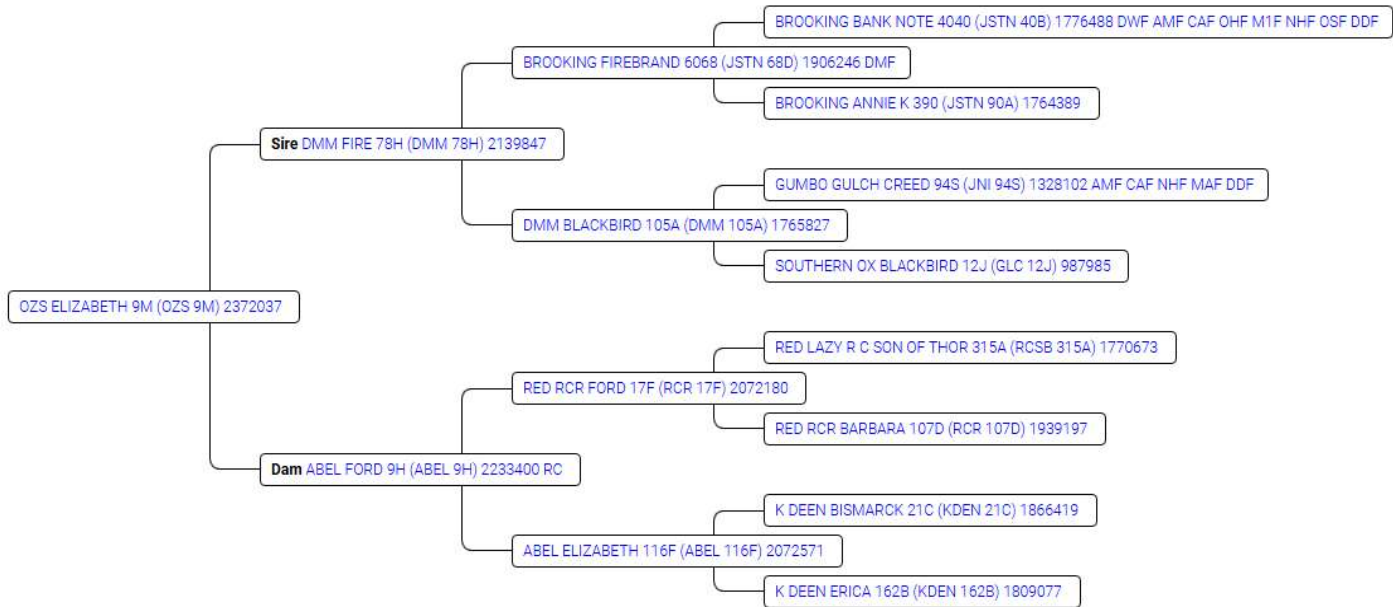

# No. 15



- ❖ **OZS ELIZABETH 54M Heifer Calf.**
- ❖ **The sire is DMM FIRE 78H, a son of Brooking Firebrand 6068.**
  - 🇺🇸 CAA No. 2372875, JUNE 1, 2024
  - 🇺🇸 BW = 91 lbs.
  - 🇺🇸 WW = 442 lbs.
- ❖ This nicely built heifer has some legacy Blackbird genetic lines.
- ❖ She is expected to be a top performer, supported by high-quality genetics on both sides.

| #   | CED  | BW   | WW   | YW   | RADG  | DMI   | Scrotal | DOC  | Claw  | Angle | CWT  | Marble | REA   | Fat    | HPG  | CEM   | Milk |
|---|------|------|------|------|-------|-------|---------|------|-------|-------|------|--------|-------|--------|------|-------|------|
| EPD   | -7.0 | +4.8 | +62  | +102 |       |       |         |      |       |       |      |        |       |        |      | -5.0  | +22  |
| ACC   | P    | P    | P    | P    |       |       |         |      |       |       |      |        |       |        |      | P     | P    |
| Breed Avg (Click for Percentiles)                       |      |      |      |      |       |       |         |      |       |       |      |        |       |        |      |       |      |
| EPD   | +3.3 | +2.0 | +54  | +95  | +0.24 | +0.91 | +0.86   | +18  | +0.44 | +0.45 | +43  | +0.47  | +0.53 | +0.020 | +11  | +6.4  | +23  |
| EPD Percentiles for OZS BLACKBIRD 54M (OZS 54M) 2372875 |      |      |      |      |       |       |         |      |       |       |      |        |       |        |      |       |      |
|   | 98 % | 95 % | 24 % | 38 % | 50 %  | 50 %  | 50 %    | 50 % | 50 %  | 50 %  | 50 % | 50 %   | 50 %  | 50 %   | 50 % | 100 % | 58 % |

## Animal Enquiry

**Registration No.** OZS BLACKBIRD 54M (OZS 54M) 2372875  
**Rego Status** Registered  
**LE Tattoo**  
**Tattoo** OZS 54M  
**Date of Birth** 01 Jun 2024  
**Sire** DMM FIRE 78H (DMM 78H) 2139847  
**Dam** ABEL 54H (ABEL 54H) 2196196  
**Recipient Dam**

- Details
- Pedigree
- Progeny
- EPDs
- Traits
- Ownership
- Breeder

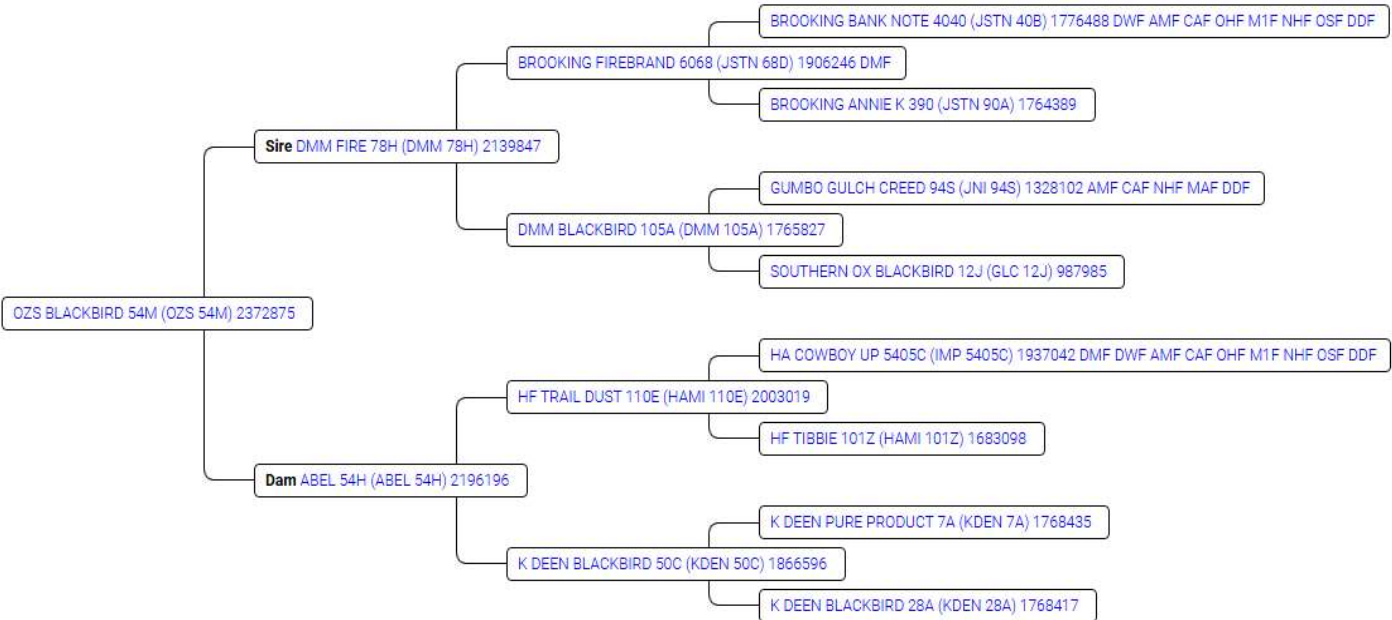



**No. 16**



- ❖ **FORD 12L Heifer.**
- ❖ **Sire is ABEL 1H (2202721). The son of DMM GUS**
  - 🇺🇸 CAA No. 2315256, APRIL 15, 2023
  - 🇺🇸 BW = 75 lbs.
- ❖ This is a well-built young heifer, would be a great addition to your herd.
- ❖ This heifer has excellent potential for growth and will develop into a durable genetic line known for good calving ease and temperament.
- ❖ Bred to **Abel G Man 55K CCA 2299594**, exposed 62 days.

| #   | CED  | BW   | WW   | YW   | RADG  | DMI   | Scrotal | DOC  | Claw  | Angle | CWT  | Marble | REA   | Fat    | HPG  | CEM  | Milk |
|---|------|------|------|------|-------|-------|---------|------|-------|-------|------|--------|-------|--------|------|------|------|
| EPD   | -1.0 | +2.7 | +43  | +77  |       |       |         |      |       |       |      |        |       |        |      | +1.0 | +26  |
| ACC   | 17   | 31   | 25   | 21   |       |       |         |      |       |       |      |        |       |        |      | 6    | 7    |
| Breed Avg (Click for Percentiles)                       |      |      |      |      |       |       |         |      |       |       |      |        |       |        |      |      |      |
| EPD   | +3.3 | +2.0 | +54  | +95  | +0.24 | +0.91 | +0.86   | +18  | +0.44 | +0.45 | +43  | +0.47  | +0.53 | +0.020 | +11  | +6.4 | +23  |
| EPD Percentiles for SELINGER FORD 12L (OZS 12L) 2315256 |      |      |      |      |       |       |         |      |       |       |      |        |       |        |      |      |      |
|   | 80 % | 64 % | 82 % | 81 % | 50 %  | 50 %  | 50 %    | 50 % | 50 %  | 50 %  | 50 % | 50 %   | 50 %  | 50 %   | 50 % | 92 % | 22 % |

**Animal Enquiry**

**Registration No.** SELINGER FORD 12L (OZS 12L) 2315256  
**Rego Status** Registered  
**LE Tattoo**  
**Tattoo** OZS 12L  
**Date of Birth** 15 Apr 2023  
**Sire** ABEL 1H (ABEL 1H) 2202721  
**Dam** ABEL FORD 9H (ABEL 9H) 2233400 RC  
**Recipient Dam**

**Status** Active  
**RE Tattoo** OZS 12L  
**Sex** Female  
**Management Tag** 12L

- Details
- Pedigree**
- Progeny
- EPDs
- Traits
- Ownership
- Breeder

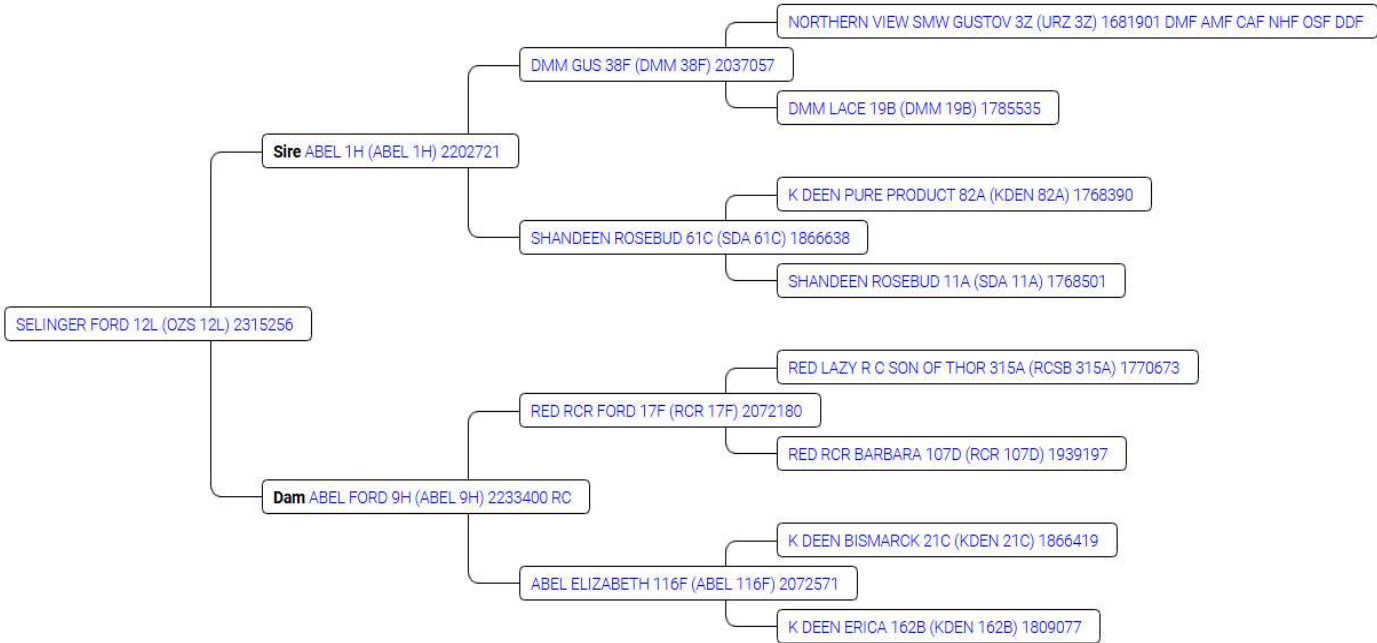

**No. 17**



- ❖ **ESTHER 13L Heifer.**
- ❖ **Sire is ABEL 1H, the son of DMM GUS. The son of DMM GUS.**
  - 🇺🇸 CAA No. 2315257, APRIL 16, 2023
  - 🇺🇸 BW = 83 lbs.
- ❖ This heifer has an easy-going temperament, thickness throughout, and will give you high quality offspring year after year. She would be a valuable addition to any herd.
- ❖ Bred to **Abel G Man 55K CCA 2299594** exposed 62 days

| #   | CED  | BW   | WW   | YW   | RADG  | DMI   | Scrotal | DOC  | Claw  | Angle | CWT  | Marble | REA   | Fat    | HPG  | CEM  | Milk |
|---|------|------|------|------|-------|-------|---------|------|-------|-------|------|--------|-------|--------|------|------|------|
| EPD   | -6.0 | +4.1 | +58  | +105 |       |       |         |      |       |       |      |        |       |        |      | -2.0 | +28  |
| ACC   | 16   | 30   | 25   | 19   |       |       |         |      |       |       |      |        |       |        |      | 6    | 6    |
| Breed Avg (Click for Percentiles)                         |      |      |      |      |       |       |         |      |       |       |      |        |       |        |      |      |      |
| EPD   | +3.3 | +2.0 | +54  | +95  | +0.24 | +0.91 | +0.86   | +18  | +0.44 | +0.45 | +43  | +0.47  | +0.53 | +0.020 | +11  | +6.4 | +23  |
| EPD Percentiles for SELINGER ESTHER 13L (OZS 13L) 2315257 |      |      |      |      |       |       |         |      |       |       |      |        |       |        |      |      |      |
|   | 97 % | 89 % | 36 % | 31 % | 50 %  | 50 %  | 50 %    | 50 % | 50 %  | 50 %  | 50 % | 50 %   | 50 %  | 50 %   | 50 % | 98 % | 11 % |

**Animal Enquiry**

**Registration No.** SELINGER ESTHER 13L (OZS 13L) 2315257  
**Rego Status** Registered  
**LE Tattoo**  
**Tattoo** OZS 13L  
**Date of Birth** 16 Apr 2023  
**Sire** ABEL 1H (ABEL 1H) 2202721  
**Dam** ABEL ESTHER 57H (ABEL 57H) 2203772  
**Recipient Dam**

**Status** Active  
**RE Tattoo** OZS 13L  
**Sex** Female  
**Management Tag** 13L

- Details
- Pedigree
- Progeny
- EPDs
- Traits
- Ownership
- Breeder

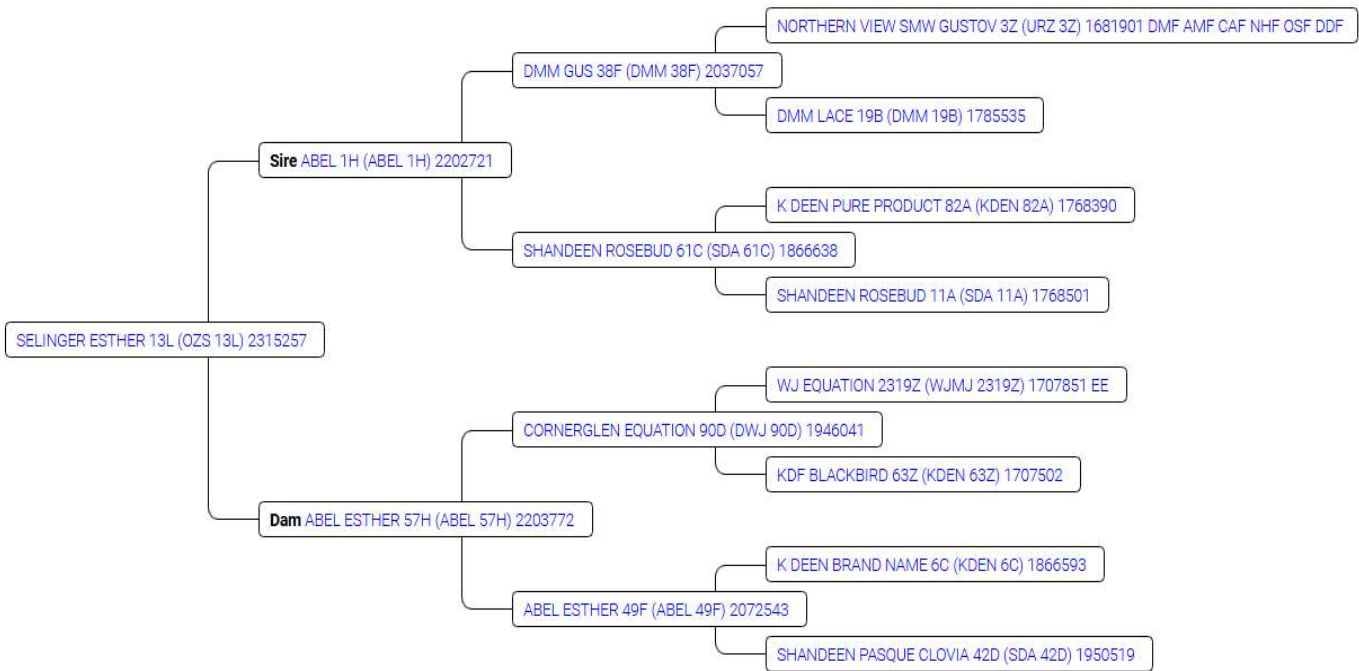

# No. 18



- ❖ **EEBONI 14L Heifer.**
- ❖ **Sired by ABEL 1H (2202721). The son of DMM GUS.**
  - 🇺🇸 **CAA No. 2315261, APRIL 17, 2023**
  - 🇺🇸 **BW = 73 lbs.**
- ❖ This is a wonderfully built young heifer
- ❖ Her dam has great maternal instincts, and provides excellent calving ease.
- ❖ This first-time heifer will carry on those genetic traits for years to come.
- ❖ Bred to **Abel G Man 55K CCA 2299594** exposed 62 days

| #  | CED  | BW   | WW  | YW  | RADG  | DMI   | Scrotal | DOC | Claw  | Angle | CWT | Marble | REA   | Fat    | HPG | CEM  | Milk |
|--|------|------|-----|-----|-------|-------|---------|-----|-------|-------|-----|--------|-------|--------|-----|------|------|
| EPD  | +1.0 | +1.9 | +51 | +92 |       |       |         |     |       |       |     |        |       |        |     | +2.0 | +25  |
| ACC  | 16   | 31   | 25  | 21  |       |       |         |     |       |       |     |        |       |        |     | 6    | 6    |
| Breed Avg (Click for Percentiles)                        |      |      |     |     |       |       |         |     |       |       |     |        |       |        |     |      |      |
| EPD  | +3.3 | +2.0 | +54 | +95 | +0.24 | +0.91 | +0.86   | +18 | +0.44 | +0.45 | +43 | +0.47  | +0.53 | +0.020 | +11 | +6.4 | +23  |
| EPD Percentiles for SELINGER EBONI 14L (OZS 14L) 2315261 |      |      |     |     |       |       |         |     |       |       |     |        |       |        |     |      |      |
|  | 66%  | 45%  | 60% | 56% | 50%   | 50%   | 50%     | 50% | 50%   | 50%   | 50% | 50%    | 50%   | 50%    | 50% | 88%  | 30%  |

## Animal Enquiry

**Registration No.** SELINGER EBONI 14L (OZS 14L) 2315261  
**Rego Status** Registered  
**LE Tattoo**  
**Tattoo** OZS 14L  
**Date of Birth** 17 Apr 2023  
**Sire** ABEL 1H (ABEL 1H) 2202721  
**Dam** ABEL EBONI 16H (ABEL 16H) 2241268  
**Recipient Dam**

**Status** Active  
**RE Tattoo** OZS 14L  
**Sex** Female  
**Management Tag** 14L

- Details
- Pedigree
- Progeny
- EPDs
- Traits
- Ownership
- Breeder

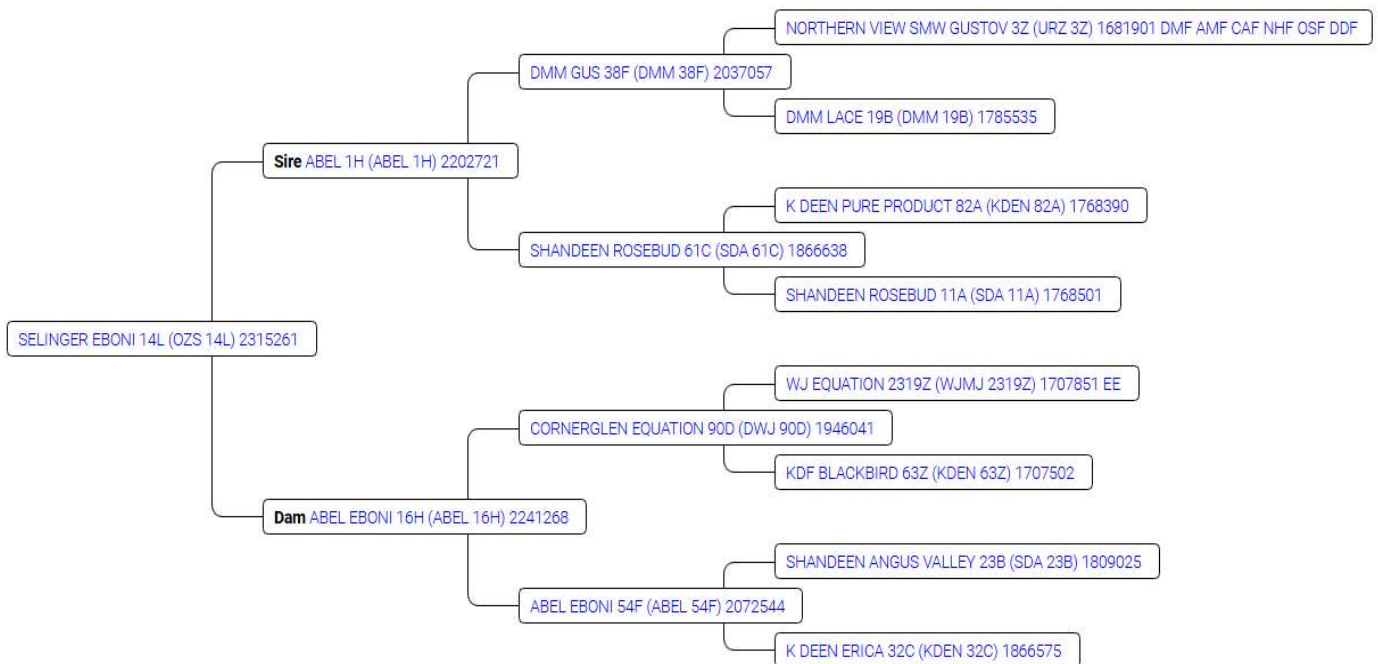

**No. 19**



- ❖ **ELLIE 19L Heifer.**
- ❖ **Sired by ABEL 1H (2202721). The son of DMM GUS.**
  - 🇺🇸 CAA No. 2315274, MAY 14, 2023
  - 🇺🇸 BW = 83 lbs.
- ❖ The picture does not do justice to this good young heifer.
- ❖ She has proven diverse genetics with plenty of room to grow, making her a great performer.
- ❖ Bred to **Abel G Man 55K CCA 2299594** exposed 62 days

| #  | CED  | BW   | WW   | YW   | RADG  | DMI   | Scrotal | DOC  | Claw  | Angle | CWT  | Marble | REA   | Fat    | HPG  | CEM  | Milk |
|--|------|------|------|------|-------|-------|---------|------|-------|-------|------|--------|-------|--------|------|------|------|
| EPD  | +4.0 | +1.2 | +30  | +64  |       |       |         |      |       |       |      |        |       |        |      | +4.0 | +23  |
| ACC  | 16   | 31   | 25   | 21   |       |       |         |      |       |       |      |        |       |        |      | 6    | 6    |
| Breed Avg (Click for Percentiles)                        |      |      |      |      |       |       |         |      |       |       |      |        |       |        |      |      |      |
| EPD  | +3.3 | +2.0 | +54  | +95  | +0.24 | +0.91 | +0.86   | +18  | +0.44 | +0.45 | +43  | +0.47  | +0.53 | +0.020 | +11  | +6.4 | +23  |
| EPD Percentiles for SELINGER ELLIE 19L (OZS 19L) 2315274 |      |      |      |      |       |       |         |      |       |       |      |        |       |        |      |      |      |
|  | 41 % | 30 % | 98 % | 93 % | 50 %  | 50 %  | 50 %    | 50 % | 50 %  | 50 %  | 50 % | 50 %   | 50 %  | 50 %   | 50 % | 73 % | 49 % |

**Animal Enquiry**

**Registration No.** SELINGER ELLIE 19L (OZS 19L) 2315274  
**Rego Status** Registered  
**LE Tattoo**  
**Tattoo** OZS 19L  
**Date of Birth** 14 May 2023  
**Sire** ABEL 1H (ABEL 1H) 2202721  
**Dam** ABEL 52H (ABEL 52H) 2224542  
**Recipient Dam**

**Status** Active  
**RE Tattoo** OZS 19L  
**Sex** Female  
**Management Tag** 19L

- Details
- Pedigree
- Progeny
- EPDs
- Traits
- Ownership
- Breeder

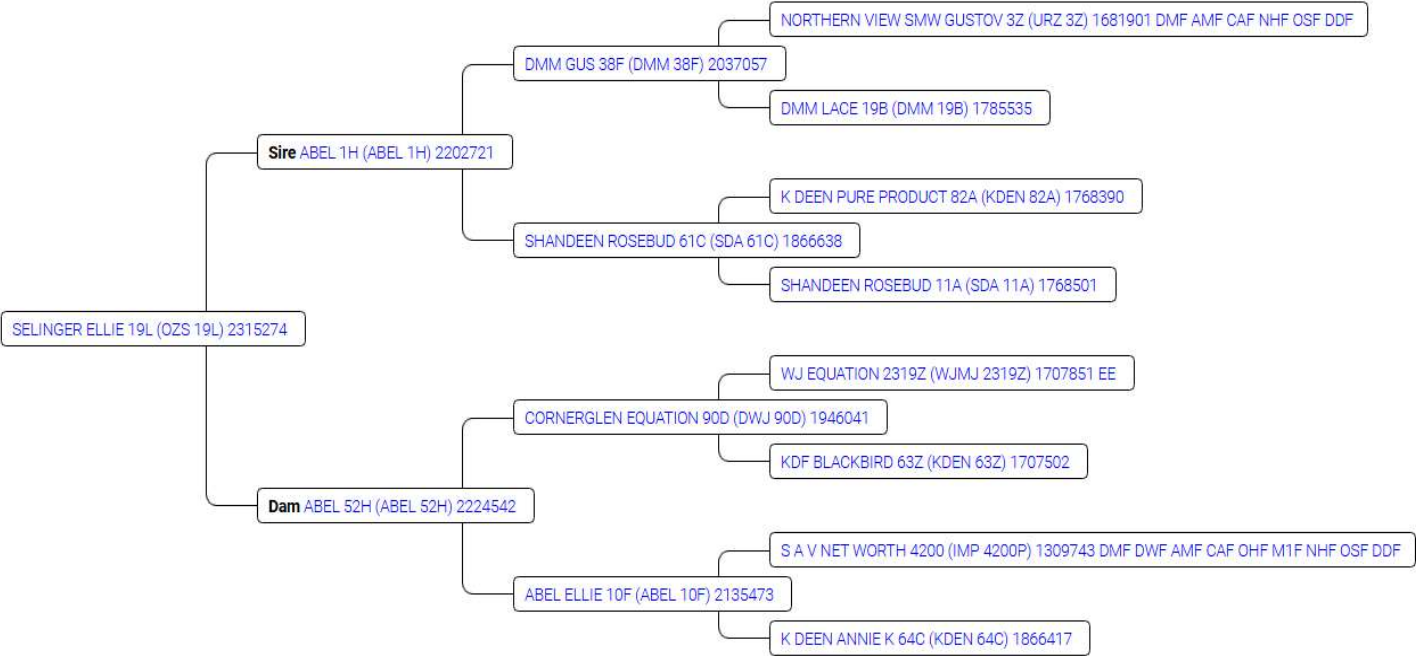



- ❖ **ESTHER 16H Cow.**
- ❖ **Sired by CORNERGLEN EQUATION 90D.**
  - 🇺🇸 CAA No. 2241268, APRIL 225, 2020
  - 🇺🇸 BW = 73 lbs.
- ❖ This is a well-built LONG FRAMED COW, would be a great addition to your herd.
- ❖ Dam originates from the Erica line at Abel Farms and has a great temperament. I have never had any problems with her, and she produces an exceptional calf year after year.
- ❖ Bred to **DMM FIRE 78H**, a son of **Brooking Firebrand 6068**, exposed 62 days

| #   | CED  | BW   | WW   | YW   | RADG  | DMI   | Scrotal | DOC  | Claw  | Angle | CWT  | Marble | REA   | Fat    | HPG  | CEM  | Milk |
|---|------|------|------|------|-------|-------|---------|------|-------|-------|------|--------|-------|--------|------|------|------|
| EPD   | +2.0 | +2.3 | +55  | +99  |       |       |         |      | +0.40 | +0.51 |      |        |       |        |      | +6.0 | +23  |
| ACC   | 22   | 37   | 30   | 26   |       |       |         |      | 17    | 17    |      |        |       |        |      | 16   | 17   |
| Breed Avg (Click for Percentiles)                     |      |      |      |      |       |       |         |      |       |       |      |        |       |        |      |      |      |
| EPD   | +3.3 | +2.0 | +54  | +95  | +0.24 | +0.91 | +0.86   | +18  | +0.44 | +0.45 | +43  | +0.47  | +0.53 | +0.020 | +11  | +6.4 | +23  |
| EPD Percentiles for ABEL EBONI 16H (ABEL 16H) 2241268 |      |      |      |      |       |       |         |      |       |       |      |        |       |        |      |      |      |
|   | 58 % | 54 % | 46 % | 42 % | 50 %  | 50 %  | 50 %    | 50 % | 29 %  | 82 %  | 50 % | 50 %   | 50 %  | 50 %   | 50 % | 51 % | 49 % |

Animal Enquiry

|                         |   |                       |          |
|-------------------------|---|-----------------------|----------|
| <b>Registration No.</b> | ABEL EBONI 16H (ABEL 16H) 2241268         | <b>Status</b>         | Active   |
| <b>Rego Status</b>      | Registered                                | <b>RE Tattoo</b>      | ABEL 16H |
| <b>LE Tattoo</b>        |   | <b>Sex</b>            | Female   |
| <b>Tattoo</b>           | ABEL 16H                                  | <b>Management Tag</b> | 16H      |
| <b>Date of Birth</b>    | 25 Apr 2020                               |                       |          |
| <b>Sire</b>             | CORNERGLEN EQUATION 90D (DWJ 90D) 1946041 |                       |          |
| <b>Dam</b>              | ABEL EBONI 54F (ABEL 54F) 2072544         |                       |          |
| <b>Recipient Dam</b>    |   |                       |          |

- Details
- Pedigree
- Progeny
- EPDs
- Traits
- Ownership
- Breeder

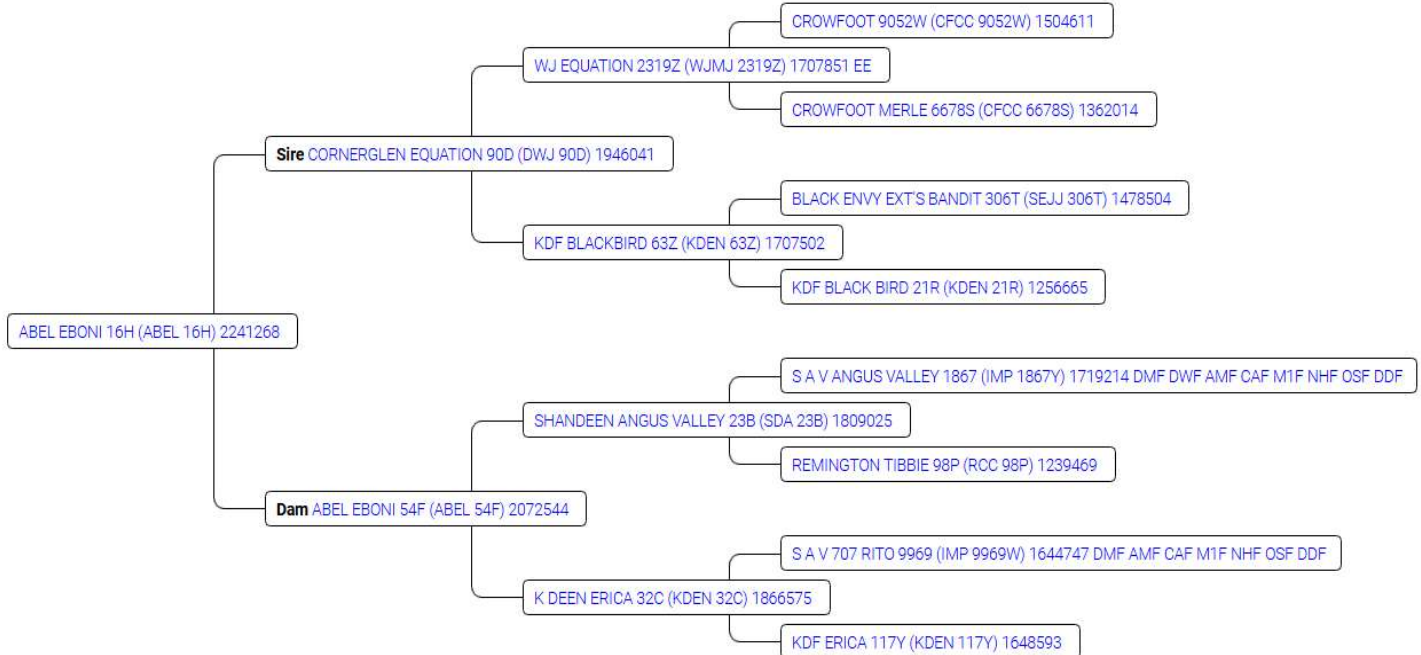

# No. 21



- ❖ **ABEL 4H Cow.**
- ❖ **Sired by CORNERGLEN EQUATION 90D.**
  - 🇺🇸 CAA No. 2196203, APRIL 19, 2020
  - 🇺🇸 BW = 81 lbs.
- ❖ This is an excellent cow and ranks among the quietest temperaments on the ranch.
- ❖ She has an exceptional udder and strong feet.
- ❖ She's one of our best mothers.
- ❖ Bred to **DMM FIRE 78H**, a son of **Brooking Firebrand 6068**, exposed 62 days ✓

| #   | CED  | BW   | WW   | YW   | RADG  | DMI   | Scrotal | DOC  | Claw  | Angle | CWT  | Marble | REA   | Fat    | HPG  | CEM  | Milk |
|---|------|------|------|------|-------|-------|---------|------|-------|-------|------|--------|-------|--------|------|------|------|
| EPD   | -3.0 | +4.5 | +56  | +101 |       |       | +0.92   |      | +0.32 | +0.38 |      |        |       |        |      | +3.0 | +22  |
| ACC   | 23   | 37   | 29   | 17   |       |       | 7       |      | 16    | 16    |      |        |       |        |      | 16   | 17   |
| Breed Avg (Click for Percentiles)             |      |      |      |      |       |       |         |      |       |       |      |        |       |        |      |      |      |
| EPD   | +3.3 | +2.0 | +54  | +95  | +0.24 | +0.91 | +0.86   | +18  | +0.44 | +0.45 | +43  | +0.47  | +0.53 | +0.020 | +11  | +6.4 | +23  |
| EPD Percentiles for ABEL 4H (ABEL 4H) 2196203 |      |      |      |      |       |       |         |      |       |       |      |        |       |        |      |      |      |
|   | 90 % | 93 % | 42 % | 39 % | 50 %  | 50 %  | 44 %    | 50 % | 6 %   | 13 %  | 50 % | 50 %   | 50 %  | 50 %   | 50 % | 82 % | 58 % |

## Animal Enquiry

**Registration No.** ABEL 4H (ABEL 4H) 2196203  
**Rego Status** Registered  
**LE Tattoo**  
**Tattoo** ABEL 4H  
**Date of Birth** 19 Apr 2020  
**Sire** CORNERGLEN EQUATION 90D (DWJ 90D) 1946041  
**Dam** ABEL ELLEN 44F (ABEL 44F) 2077432  
**Recipient Dam**

**Status** Active  
**RE Tattoo** ABEL 4H  
**Sex** Female  
**Management Tag** 4H

- Details
- Pedigree
- Progeny
- EPDs
- Traits
- Ownership
- Breeder

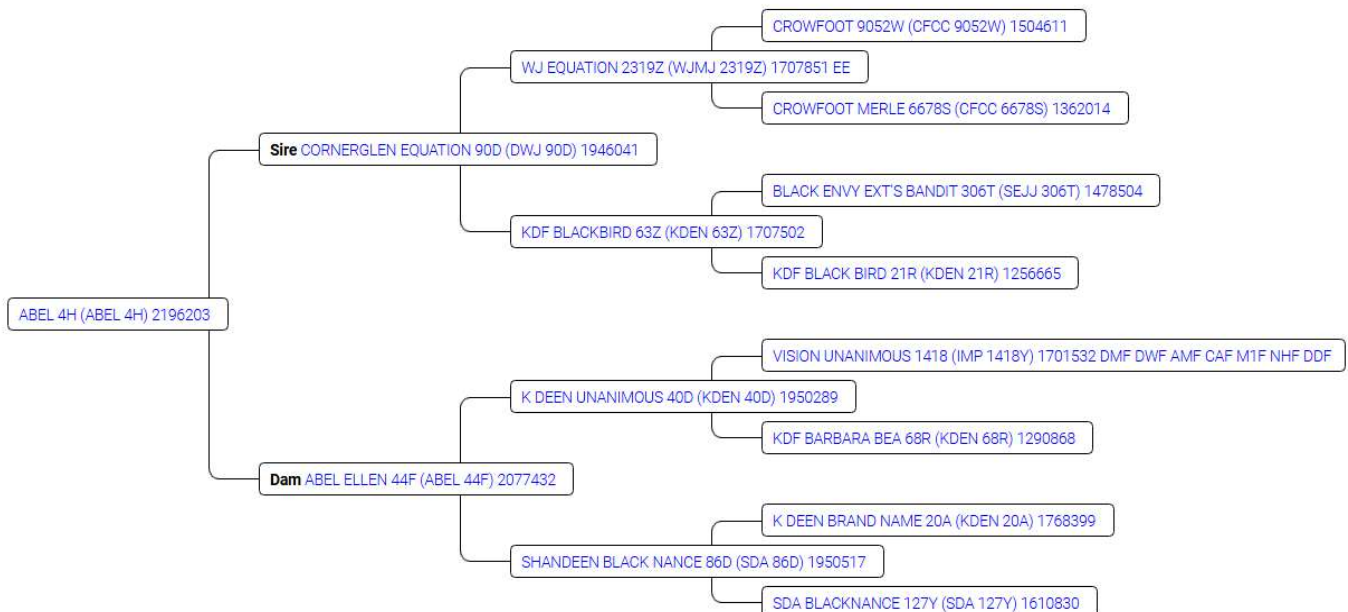



- ❖ **ABEL 52H Cow.**
- ❖ **Sired by CORNERGLEN EQUATION 90D, Genetic blood line.**
  - 🇺🇸 CAA No. 2224542, MAY 19, 2020
  - 🇺🇸 BW = 72 lbs.
- ❖ This cow has it all... great confirmation, lovely demeanor, is easy to work with, and is an excellent mother. She is one of those cows that always wants to see what you're doing.
- ❖ Bred to **DMM FIRE 78H**, a son of **Brooking Firebrand 6068**, exposed 62 days ✓

| #   | CED  | BW   | WW  | YW  | RADG  | DMI   | Scrotal | DOC | Claw  | Angle | CWT | Marble | REA   | Fat    | HPG | CEM  | Milk |
|---|------|------|-----|-----|-------|-------|---------|-----|-------|-------|-----|--------|-------|--------|-----|------|------|
| EPD   | +2.0 | +3.1 | +41 | +79 |       |       |         |     | +0.45 | +0.44 |     |        |       |        |     | +7.0 | +20  |
| ACC   | 23   | 38   | 29  | 25  |       |       |         |     | 18    | 18    |     |        |       |        |     | 17   | 17   |
| Breed Avg (Click for Percentiles)               |      |      |     |     |       |       |         |     |       |       |     |        |       |        |     |      |      |
| EPD   | +3.3 | +2.0 | +54 | +95 | +0.24 | +0.91 | +0.86   | +18 | +0.44 | +0.45 | +43 | +0.47  | +0.53 | +0.020 | +11 | +6.4 | +23  |
| EPD Percentiles for ABEL 52H (ABEL 52H) 2224542 |      |      |     |     |       |       |         |     |       |       |     |        |       |        |     |      |      |
|   | 58%  | 73%  | 86% | 79% | 50%   | 50%   | 50%     | 50% | 56%   | 42%   | 50% | 50%    | 50%   | 50%    | 50% | 39%  | 76%  |

Animal Enquiry

**Registration No.** ABEL 52H (ABEL 52H) 2224542  
**Rego Status** Registered  
**LE Tattoo**  
**Tattoo** ABEL 52H  
**Date of Birth** 19 May 2020  
**Sire** CORNERGLEN EQUATION 90D (DWJ 90D) 1946041  
**Dam** ABEL ELLIE 10F (ABEL 10F) 2135473  
**Recipient Dam**

**Status** Active  
**RE Tattoo** ABEL 52H  
**Sex** Female  
**Management Tag** 52H

- Details
- Pedigree**
- Progeny
- EPDs
- Traits
- Ownership
- Breeder

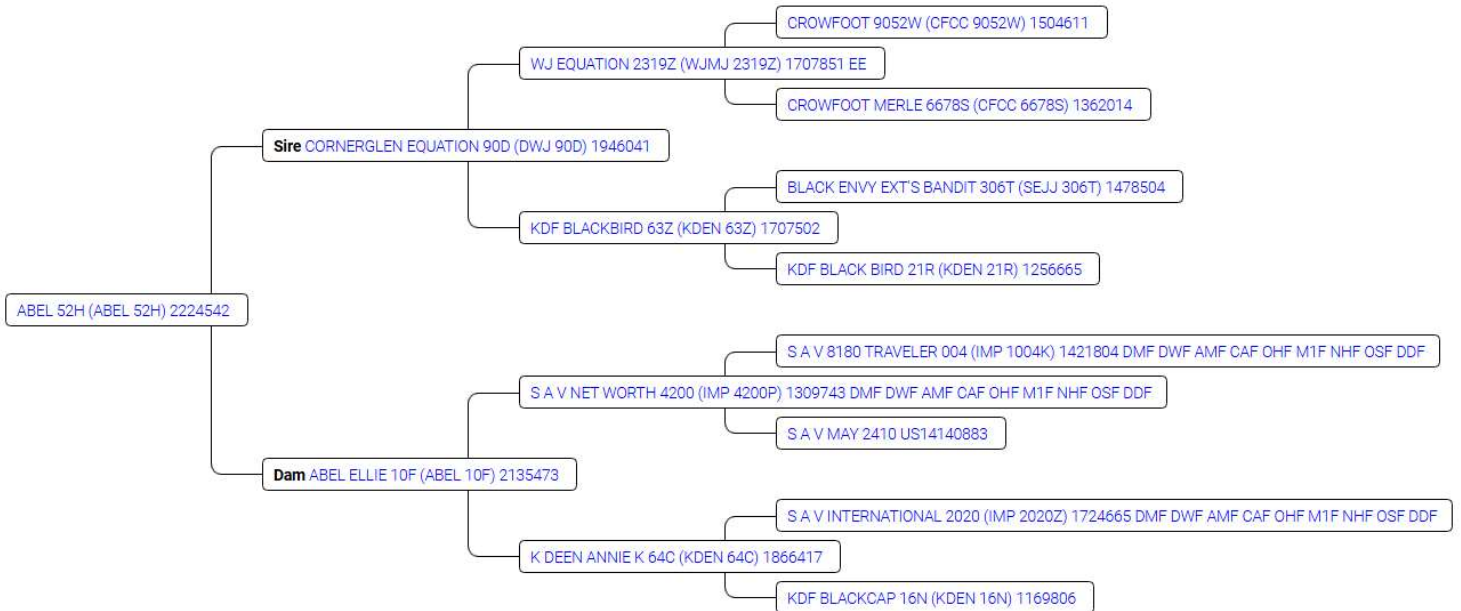

**No. 23**



- ❖ **ABEL 54H Cow.**
- ❖ **Sired by HF TRAIL DUST 110E.**
  - 🇺🇸 CAA No. 2196196, MAY 22, 2020
  - 🇺🇸 BW = 89 lbs.
- ❖ This is a well-built LONG FRAMED COW, would be a great addition to your herd.
- ❖ She has excellent conformation and mothering ability. She carries the **legacy genetic line of Blackbird** on her maternal side.
- ❖ Bred to **DMM FIRE 78H**, a son of **Brooking Firebrand 6068**, exposed 62 days

| #   | CED  | BW   | WW  | YW   | RADG  | DMI   | Scrotal | DOC | Claw  | Angle | CWT | Marble | REA   | Fat    | HPG | CEM   | Milk |
|---|------|------|-----|------|-------|-------|---------|-----|-------|-------|-----|--------|-------|--------|-----|-------|------|
| EPD   | -8.0 | +4.9 | +63 | +106 |       |       |         |     | +0.63 | +0.59 |     |        |       |        |     | -12.0 | +22  |
| ACC   | 19   | 36   | 28  | 16   |       |       |         |     | 18    | 18    |     |        |       |        |     | 17    | 13   |
| Breed Avg (Click for Percentiles)               |      |      |     |      |       |       |         |     |       |       |     |        |       |        |     |       |      |
| EPD   | +3.3 | +2.0 | +54 | +95  | +0.24 | +0.91 | +0.86   | +18 | +0.44 | +0.45 | +43 | +0.47  | +0.53 | +0.020 | +11 | +6.4  | +23  |
| EPD Percentiles for ABEL 54H (ABEL 54H) 2196196 |      |      |     |      |       |       |         |     |       |       |     |        |       |        |     |       |      |
|   | 99%  | 96%  | 22% | 30%  | 50%   | 50%   | 50%     | 50% | 99%   | 98%   | 50% | 50%    | 50%   | 50%    | 50% | 100%  | 58%  |

**Animal Enquiry**

**Registration No.** ABEL 54H (ABEL 54H) 2196196  
**Rego Status** Registered  
**LE Tattoo**  
**Tattoo** ABEL 54H  
**Date of Birth** 22 May 2020  
**Sire** HF TRAIL DUST 110E (HAMI 110E) 2003019  
**Dam** K DEEN BLACKBIRD 50C (KDEN 50C) 1866596  
**Recipient Dam**

**Status** Active  
**RE Tattoo** ABEL  
**Sex** Female  
**Management Tag** 54H

- Details
- Pedigree
- Progeny
- EPDs
- Traits
- Ownership
- Breeder

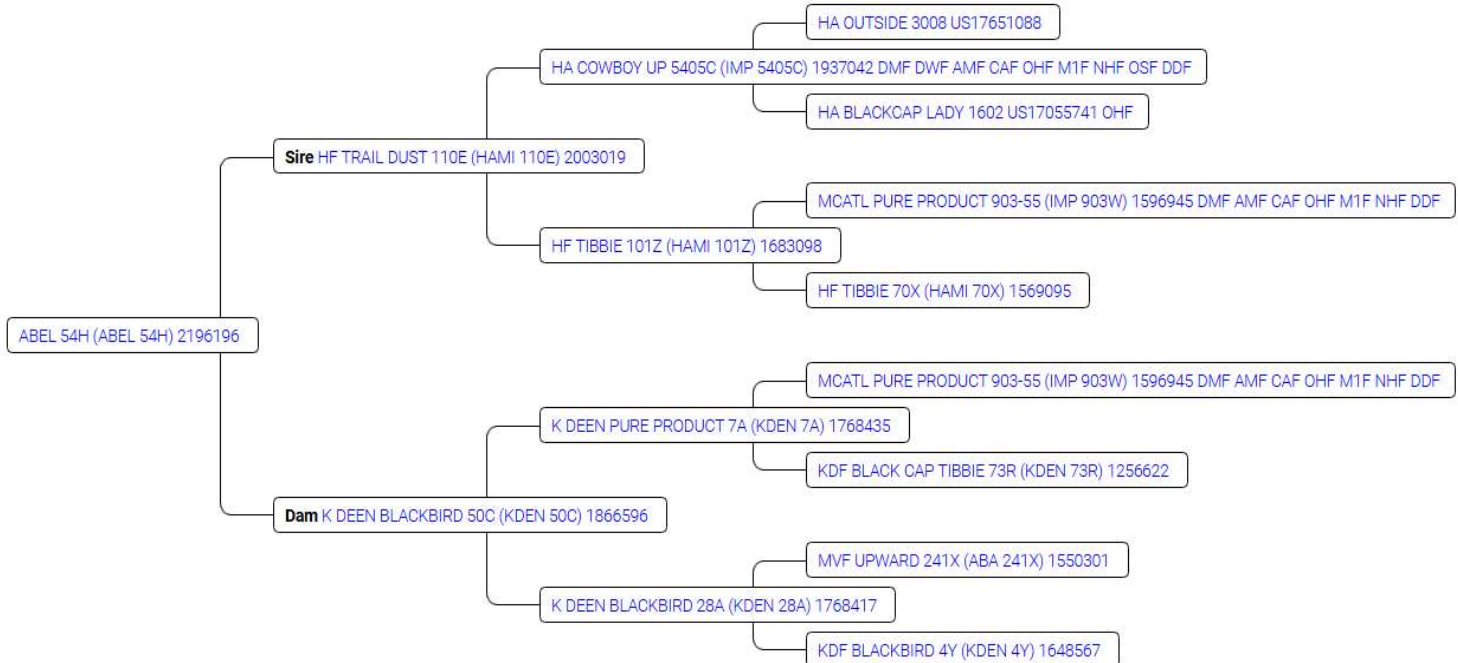





- ❖ **ABEL 57H Cow.**
- ❖ **Sired by CORNERGLEN EQUATION 90D.**
  - 🇺🇸 CAA No. 2203772, MAY 28, 2020
  - 🇺🇸 BW = 79 lbs.
- ❖ A beautifully built cow that came from Abel Farms. She has a good udder and feet, and is an easy calver and excellent mother.
- ❖ Bred to **DMM FIRE 78H**, a son of **Brooking Firebrand 6068**, exposed 62 days

| #  | CED  | BW   | WW   | YW   | RADG  | DMI   | Scrotal | DOC  | Claw  | Angle | CWT  | Marble | REA   | Fat    | HPG  | CEM  | Milk |
|--|------|------|------|------|-------|-------|---------|------|-------|-------|------|--------|-------|--------|------|------|------|
| EPD  | -6.0 | +3.9 | +63  | +106 |       |       |         |      | +0.32 | +0.38 |      |        |       |        |      | +0.0 | +29  |
| ACC  | 23   | 36   | 29   | 17   |       |       |         |      | 16    | 16    |      |        |       |        |      | 16   | 18   |
| Breed Avg (Click for Percentiles)                      |      |      |      |      |       |       |         |      |       |       |      |        |       |        |      |      |      |
| EPD  | +3.3 | +2.0 | +54  | +95  | +0.24 | +0.91 | +0.86   | +18  | +0.44 | +0.45 | +43  | +0.47  | +0.53 | +0.020 | +11  | +6.4 | +23  |
| EPD Percentiles for ABEL ESTHER 57H (ABEL 57H) 2203772 |      |      |      |      |       |       |         |      |       |       |      |        |       |        |      |      |      |
|  | 97 % | 86 % | 22 % | 30 % | 50 %  | 50 %  | 50 %    | 50 % | 6 %   | 13 %  | 50 % | 50 %   | 50 %  | 50 %   | 50 % | 95 % | 8 %  |

**Animal Enquiry**

**Registration No.** ABEL ESTHER 57H (ABEL 57H) 2203772  
**Rego Status** Registered  
**LE Tattoo**  
**Tattoo** ABEL 57H  
**Date of Birth** 28 May 2020  
**Sire** CORNERGLEN EQUATION 90D (DWJ 90D) 1946041  
**Dam** ABEL ESTHER 49F (ABEL 49F) 2072543  
**Recipient Dam**

**Status** Active  
**RE Tattoo** ABEL 57H  
**Sex** Female  
**Management Tag** 57H

- Details
- Pedigree
- Progeny
- EPDs
- Traits
- Ownership
- Breeder

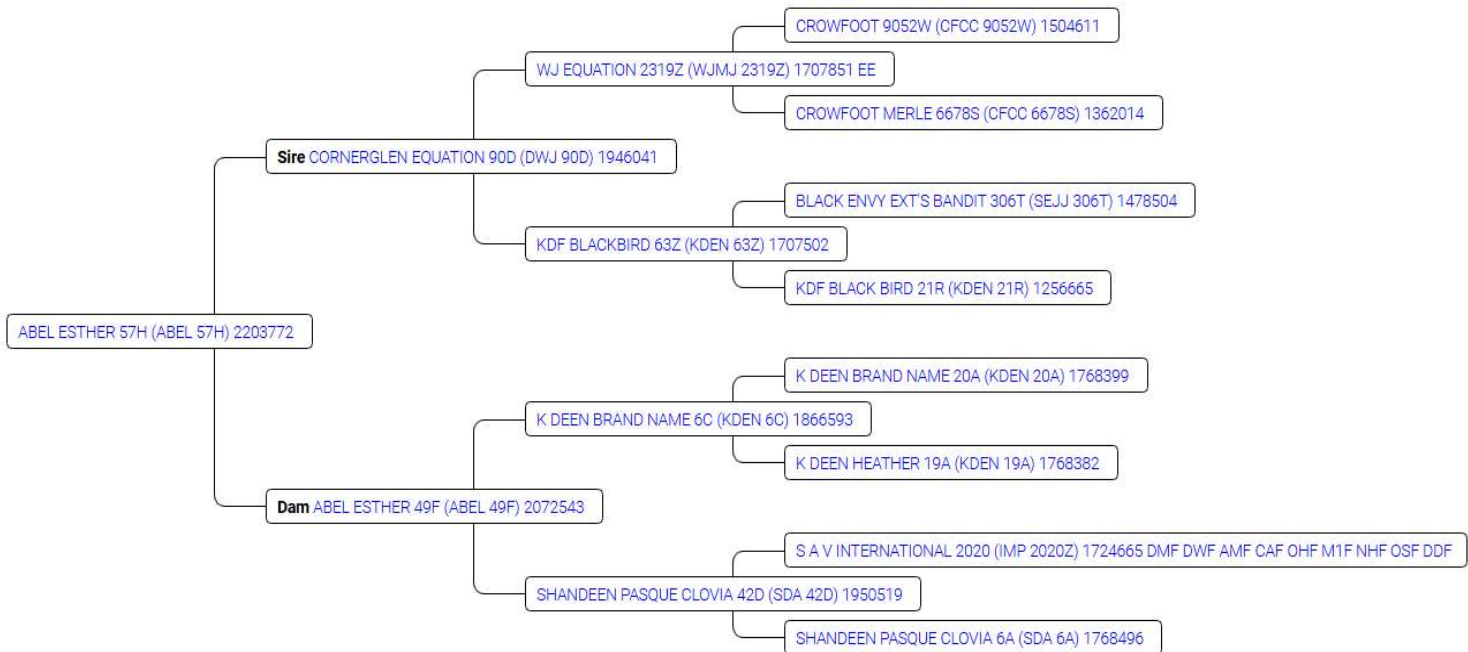



- ❖ **ABEL 63H Cow.**
- ❖ **Sired by HF TRAIL DUST 110E, Genetic blood line.**
  - 🇺🇸 CAA No. 2250541, JUNE 16, 2020
  - 🇺🇸 BW = 80 lbs.
- ❖ This cow puts all her energy into her calves, and as shown in the picture, she produces high quality calves year after year.
- ❖ Bred to **DMM FIRE 78H**, a son of **Brooking Firebrand 6068**, exposed 62 days

| #   | CED  | BW   | WW  | YW  | RADG  | DMI   | Scrotal | DOC | Claw  | Angle | CWT | Marble | REA   | Fat    | HPG | CEM   | Milk |
|---|------|------|-----|-----|-------|-------|---------|-----|-------|-------|-----|--------|-------|--------|-----|-------|------|
| EPD   | -8.0 | +5.0 | +49 | +86 |       |       | +0.56   |     | +0.52 | +0.48 |     |        |       |        | +9  | -10.0 | +16  |
| ACC   | 18   | 35   | 23  | 19  |       |       | 12      |     | 16    | 16    |     |        |       |        | P   | 18    | 19   |
| Breed Avg (Click for Percentiles)               |      |      |     |     |       |       |         |     |       |       |     |        |       |        |     |       |      |
| EPD   | +3.3 | +2.0 | +54 | +95 | +0.24 | +0.91 | +0.86   | +18 | +0.44 | +0.45 | +43 | +0.47  | +0.53 | +0.020 | +11 | +6.4  | +23  |
| EPD Percentiles for ABEL 63H (ABEL 63H) 2250541 |      |      |     |     |       |       |         |     |       |       |     |        |       |        |     |       |      |
|   | 99%  | 96%  | 66% | 67% | 50%   | 50%   | 76%     | 50% | 85%   | 67%   | 50% | 50%    | 50%   | 50%    | 74% | 100%  | 94%  |

Animal Enquiry

**Registration No.** ABEL 63H (ABEL 63H) 2250541  
**Rego Status** Registered  
**LE Tattoo**  
**Tattoo** ABEL 63H  
**Date of Birth** 16 Jun 2020  
**Sire** HF TRAIL DUST 110E (HAMI 110E) 2003019  
**Dam** KDF BLACKBIRD 113Y (KDEN 113Y) 1648615  
**Recipient Dam**

**Status** Active  
**RE Tattoo** ABEL 63H  
**Sex** Female  
**Management Tag** 63H

- Details
- Pedigree
- Progeny
- EPDs
- Traits
- Ownership
- Breeder

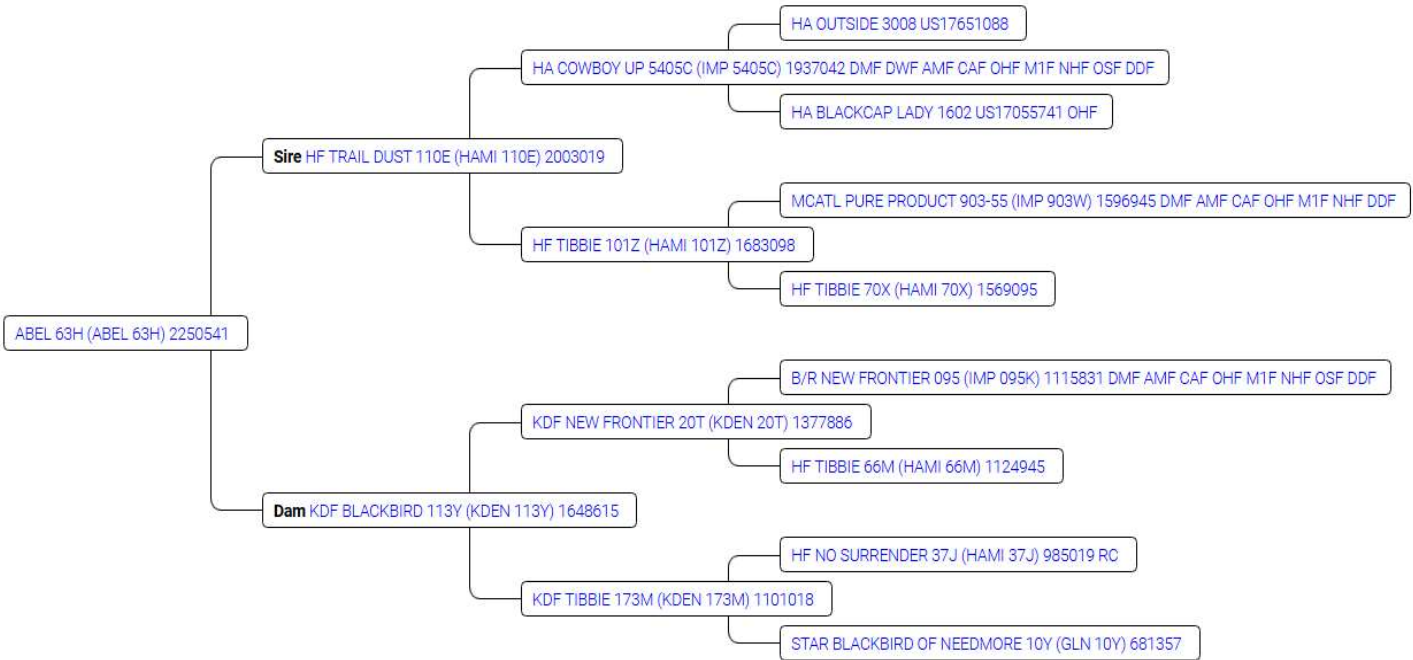

No. 26



- ❖ **ABEL FORD 9H Cow.**  
**Sired by RED RCR FORD 17F**  
 CAA No. 2233400, APRIL 22, 2020  
 BW = 78 lbs.
- ❖ This beautifully built LONG FRAMED COW with a quiet temperament would be a great addition to your herd.
- ❖ She produces exceptional calves and produces good milk, yielding good-sized weanlings year after year.
- ❖ Bred to **DMM FIRE 78H**, a son of **Brooking Firebrand 6068**, exposed 62 days ✓

| #   | CED  | BW   | WW   | YW   | RADG  | DMI   | Scrotal | DOC  | Claw  | Angle | CWT  | Marble | REA   | Fat    | HPG  | CEM  | Milk |
|---|------|------|------|------|-------|-------|---------|------|-------|-------|------|--------|-------|--------|------|------|------|
| EPD   | -3.0 | +3.4 | +42  | +72  |       |       |         |      | +0.40 | +0.42 |      |        |       |        | +12  | +3.0 | +26  |
| ACC   | 24   | 39   | 31   | 25   |       |       |         |      | 17    | 17    |      |        |       |        | 13   | 17   | 18   |
| Breed Avg (Click for Percentiles)                     |      |      |      |      |       |       |         |      |       |       |      |        |       |        |      |      |      |
| EPD   | +3.3 | +2.0 | +54  | +95  | +0.24 | +0.91 | +0.86   | +18  | +0.44 | +0.45 | +43  | +0.47  | +0.53 | +0.020 | +11  | +6.4 | +23  |
| EPD Percentiles for ABEL FORD 9H (ABEL 9H) 2233400 RC |      |      |      |      |       |       |         |      |       |       |      |        |       |        |      |      |      |
|   | 83 % | 85 % | 51 % | 53 % | 50 %  | 50 %  | 50 %    | 50 % | 30 %  | 11 %  | 50 % | 50 %   | 50 %  | 50 %   | 18 % | 72 % | 28 % |

Animal Enquiry

Registration No. ABEL FORD 9H (ABEL 9H) 2233400 RC  
 Rego Status Registered  
 LE Tattoo  
 Tattoo ABEL 9H  
 Date of Birth 22 Apr 2020  
 Sire RED RCR FORD 17F (RCR 17F) 2072180  
 Dam ABEL ELIZABETH 116F (ABEL 116F) 2072571  
 Recipient Dam

Status Active  
 RE Tattoo ABEL 9H  
 Sex Female  
 Management Tag 9H

- Details
- Pedigree
- Progeny
- EPDs
- Traits
- Ownership
- Breeder

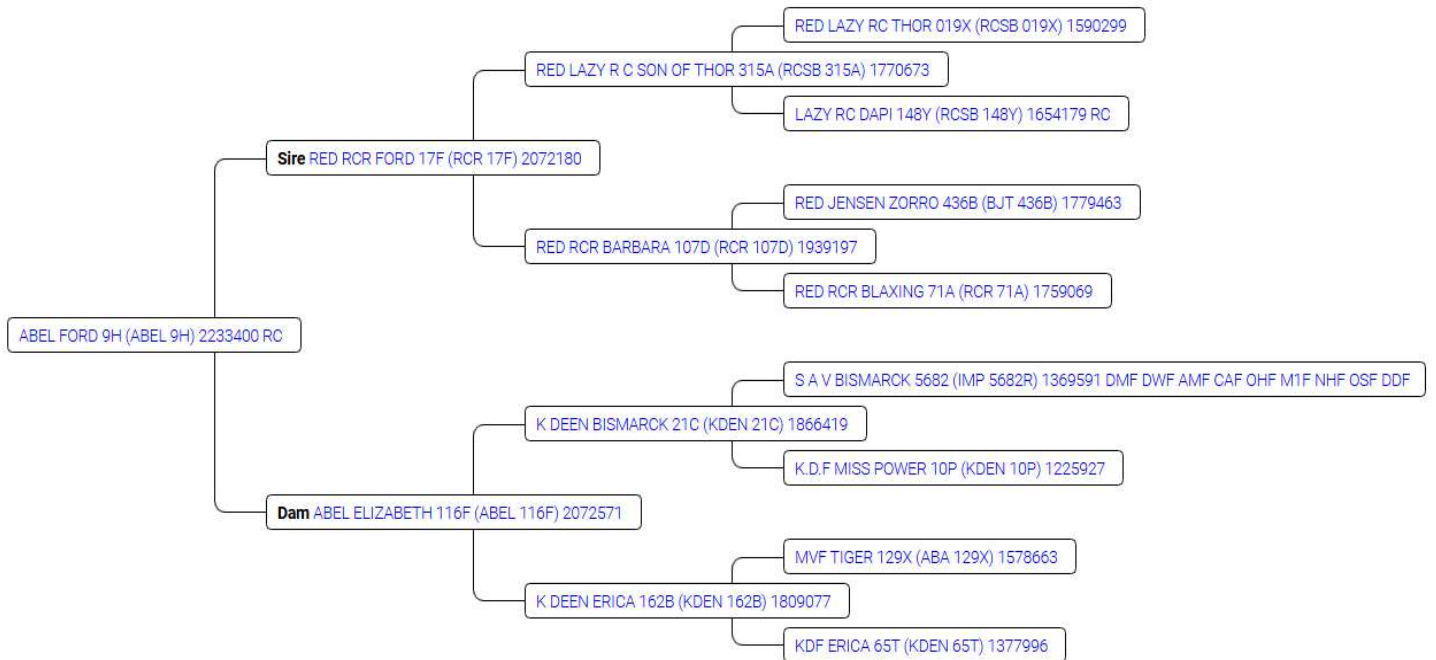

**No. 27**



- ❖ **ABEL TIBBIE 18J Cow.**
- ❖ **Sired by MVF GMAN 913G**
  - 🇺🇸 CAA No. 2240979, MAY 02, 2021
  - 🇺🇸 BW = 80 lbs.
- ❖ This cow is the real deal. She has a long, deep frame, good udder and feet and a quiet temperament.
- ❖ She carries legacy blood lines of Tibbie, which will give you deep calves.
- ❖ Bred to **DMM FIRE 78H**, a son of **Brooking Firebrand 6068**, exposed 62 days ✓

| #  | CED  | BW   | WW   | YW   | RADG  | DMI   | Scrotal | DOC  | Claw  | Angle | CWT  | Marble | REA   | Fat    | HPG  | CEM  | Milk |
|--|------|------|------|------|-------|-------|---------|------|-------|-------|------|--------|-------|--------|------|------|------|
| EPD  | +2.0 | +2.3 | +40  | +69  |       |       | +0.80   |      | +0.43 | +0.41 |      |        |       |        | +9   | +2.0 | +18  |
| ACC  | 19   | 38   | 31   | 16   |       |       | 11      |      | 14    | 8     |      |        |       |        | P    | 15   | 17   |
| Breed Avg (Click for Percentiles)                      |      |      |      |      |       |       |         |      |       |       |      |        |       |        |      |      |      |
| EPD  | +3.3 | +2.0 | +54  | +95  | +0.24 | +0.91 | +0.86   | +18  | +0.44 | +0.45 | +43  | +0.47  | +0.53 | +0.020 | +11  | +6.4 | +23  |
| EPD Percentiles for ABEL TIBBIE 18J (ABEL 18J) 2240979 |      |      |      |      |       |       |         |      |       |       |      |        |       |        |      |      |      |
|  | 58 % | 54 % | 88 % | 90 % | 50 %  | 50 %  | 56 %    | 50 % | 45 %  | 25 %  | 50 % | 50 %   | 50 %  | 50 %   | 68 % | 88 % | 87 % |

**Animal Enquiry**

**Registration No.** ABEL TIBBIE 18J (ABEL 18J) 2240979  
**Rego Status** Registered  
**LE Tattoo**  
**Tattoo** ABEL 18J  
**Date of Birth** 02 May 2021  
**Sire** MVF G MAN 913G (ABA 913G) 2100901  
**Dam** K DEEN TIBBIE 27C (KDEN 27C) 1866564  
**Recipient Dam**

**Status** Active  
**RE Tattoo** ABEL 18J  
**Sex** Female  
**Management Tag** 18J

- Details
- Pedigree**
- Progeny
- EPDs
- Traits
- Ownership
- Breeder

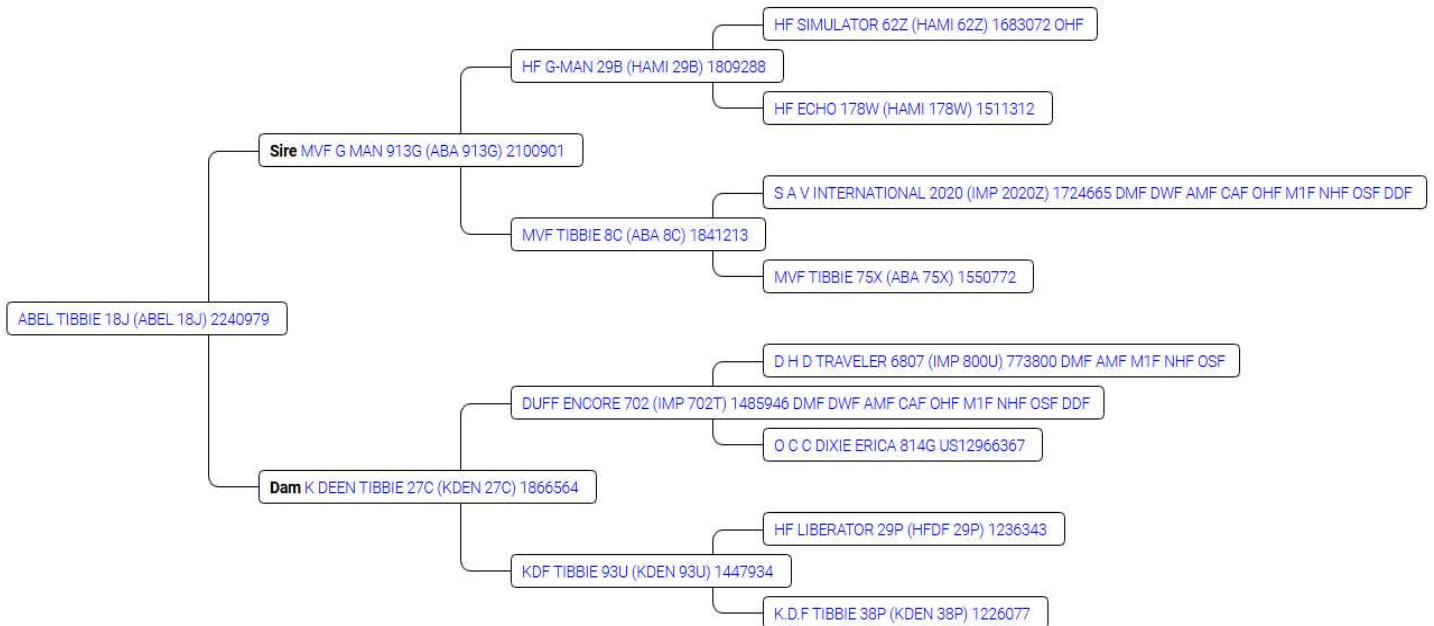

**No. 28**



- ❖ **ABEL LASS 50J Cow**
- ❖ **Sired by MVF GMAN 913G**
  - 🇺🇸 CAA No. 2240973, MAY 29, 2021
  - 🇺🇸 BW = 80 lbs.
- ❖ This cow has a good temperament; she is easy to work with and quiet.
- ❖ Her genetics come from G-Man; a respected bull line known for consistently producing large calves.
- ❖ Bred to **DMM FIRE 78H**, a son of **Brooking Firebrand 6068**, exposed 62 days ✓

| #  | CED  | BW   | WW   | YW   | RADG  | DMI   | Scrotal | DOC  | Claw  | Angle | CWT  | Marble | REA   | Fat    | HPG  | CEM  | Milk |
|--|------|------|------|------|-------|-------|---------|------|-------|-------|------|--------|-------|--------|------|------|------|
| EPD  | +1.0 | +2.9 | +65  | +111 |       |       |         |      | +0.34 | +0.38 |      |        |       |        |      | +4.0 | +26  |
| ACC  | 18   | 36   | 30   | 15   |       |       |         |      | 12    | 5     |      |        |       |        |      | 15   | 17   |
| Breed Avg (Click for Percentiles)                    |      |      |      |      |       |       |         |      |       |       |      |        |       |        |      |      |      |
| EPD  | +3.3 | +2.0 | +54  | +95  | +0.24 | +0.91 | +0.86   | +18  | +0.44 | +0.45 | +43  | +0.47  | +0.53 | +0.020 | +11  | +6.4 | +23  |
| EPD Percentiles for ABEL LASS 50J (ABEL 50J) 2240973 |      |      |      |      |       |       |         |      |       |       |      |        |       |        |      |      |      |
|  | 66 % | 68 % | 17 % | 22 % | 50 %  | 50 %  | 50 %    | 50 % | 9 %   | 13 %  | 50 % | 50 %   | 50 %  | 50 %   | 50 % | 73 % | 22 % |

**Animal Enquiry**

**Registration No.** ABEL LASS 50J (ABEL 50J) 2240973  
**Rego Status** Registered  
**LE Tattoo**  
**Tattoo** ABEL 50J  
**Date of Birth** 29 May 2021  
**Sire** MVF G MAN 913G (ABA 913G) 2100901  
**Dam** KDF ROYAL LASS 12Y (KDEN 12Y) 1648578  
**Recipient Dam**

**Status** Active  
**RE Tattoo** ABEL 50J  
**Sex** Female  
**Management Tag** 50J

- Details
- Pedigree
- Progeny
- EPDs
- Traits
- Ownership
- Breeder

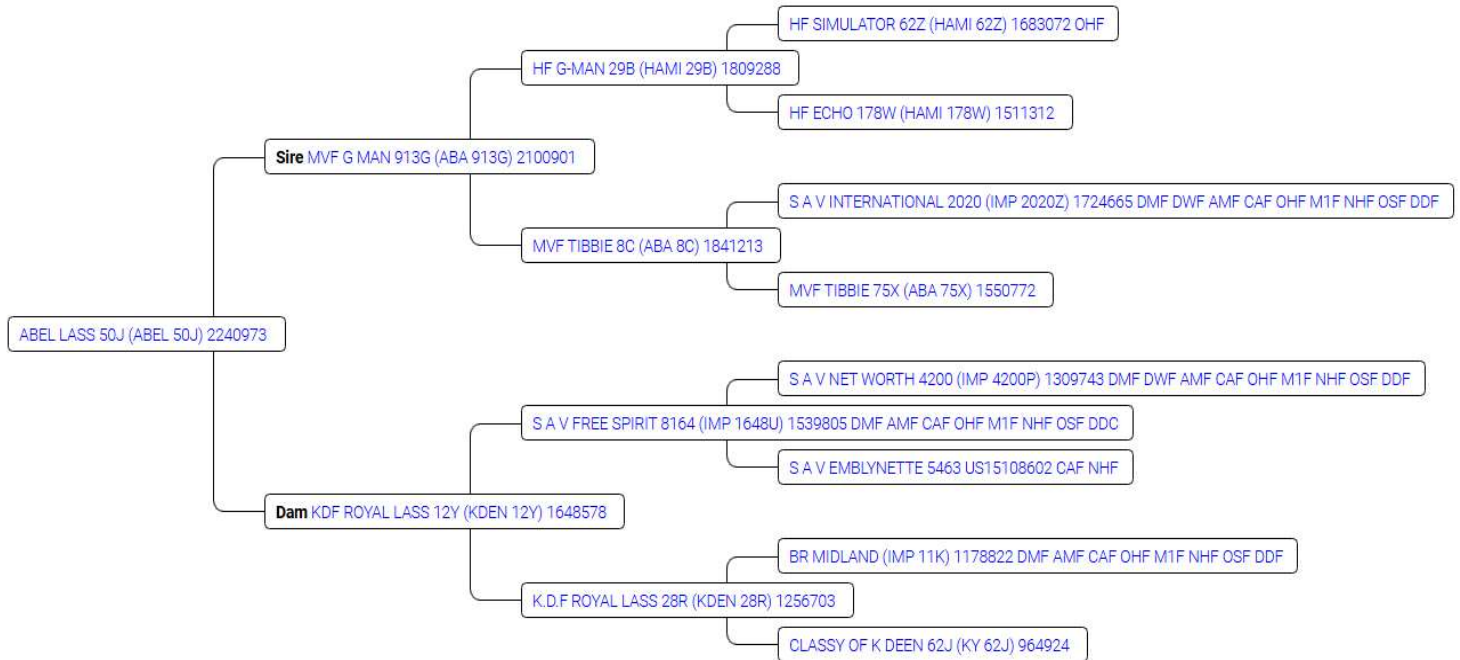

No. 29



- ❖ **SELINGER OZS 4K Cow.**
- ❖ **Sired by ABEL 1H (2202721). The son of DMM GUS.**
- 🇺🇸 CAA No. 2290395, MAY 08, 2022
- 🇺🇸 BW = 73 lbs.
- ❖ First time calver in 2024.
- ❖ This young cow comes from Abel 4H, a calm lineage we have maintained for years.
- ❖ The top side of this cow's lineage is the bull Gus, known for his great size, length, and depth.
- ❖ Bred to **Abel G Man 55K CCA 2299594** exposed 62 days

| #  | CED  | BW   | WW  | YW  | RADG  | DMI   | Scrotal | DOC | Claw  | Angle | CWT | Marble | REA   | Fat    | HPG | CEM  | Milk |
|--|------|------|-----|-----|-------|-------|---------|-----|-------|-------|-----|--------|-------|--------|-----|------|------|
| EPD  | +0.0 | +1.9 | +40 | +73 |       |       |         |     |       |       |     |        |       |        |     | +2.0 | +26  |
| ACC  | 21   | 31   | 24  | 13  |       |       |         |     |       |       |     |        |       |        |     | 11   | 7    |
| Breed Avg (Click for Percentiles)                    |      |      |     |     |       |       |         |     |       |       |     |        |       |        |     |      |      |
| EPD  | +3.3 | +2.0 | +54 | +95 | +0.24 | +0.91 | +0.86   | +18 | +0.44 | +0.45 | +43 | +0.47  | +0.53 | +0.020 | +11 | +6.4 | +23  |
| EPD Percentiles for SELINGER OZS 4K (OZS 4K) 2290395 |      |      |     |     |       |       |         |     |       |       |     |        |       |        |     |      |      |
|  | 73%  | 45%  | 88% | 86% | 50%   | 50%   | 50%     | 50% | 50%   | 50%   | 50% | 50%    | 50%   | 50%    | 50% | 88%  | 22%  |

Animal Enquiry

Registration No. SELINGER OZS 4K (OZS 4K) 2290395  
 Rego Status Registered  
 LE Tattoo  
 Tattoo OZS 4K  
 Date of Birth 08 May 2022  
 Sire ABEL 1H (ABEL 1H) 2202721  
 Dam ABEL FORD 9H (ABEL 9H) 2233400 RC  
 Recipient Dam

Status Active  
 RE Tattoo OZS 4K  
 Sex Female  
 Management Tag 4K

- Details
- Pedigree
- Progeny
- EPDs
- Traits
- Ownership
- Breeder

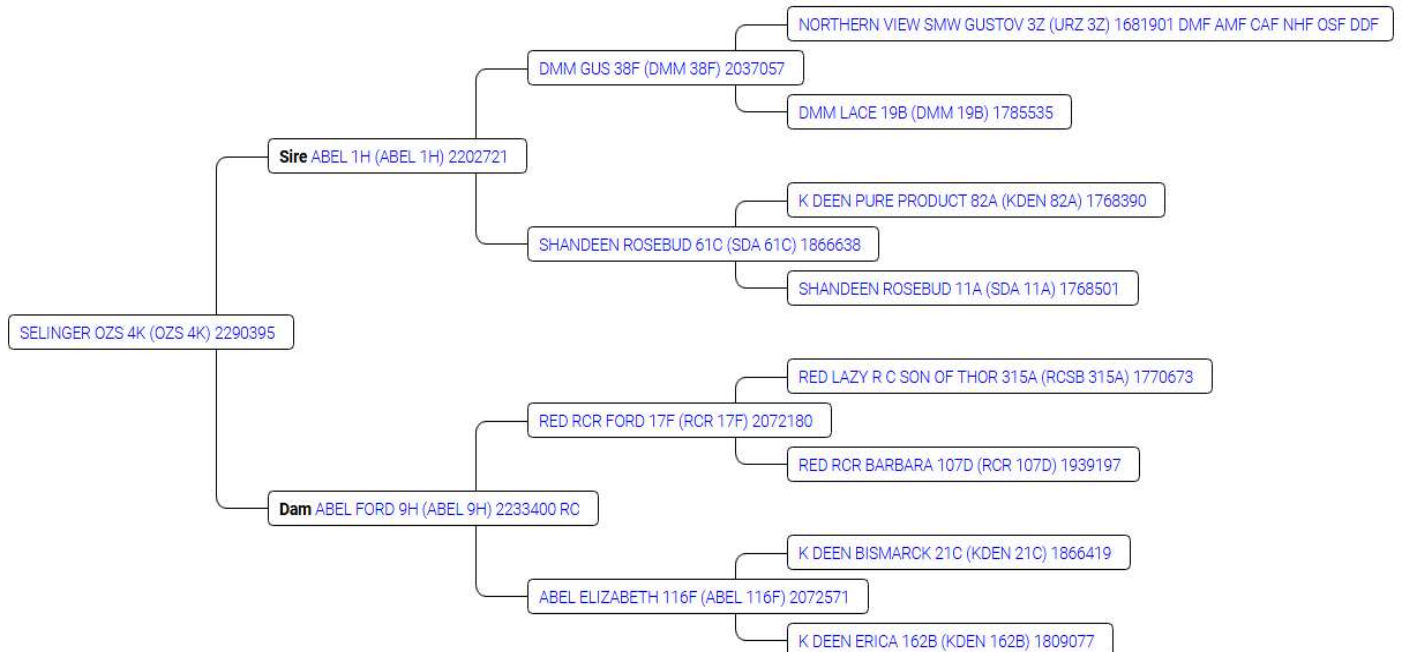

**No. 30**



- ❖ **SELINGER OZS 5K Cow,**
- ❖ **Sired by ABEL 1H (2202721). The son of DMM GUS.**
  - 🇺🇸 CAA No. 2290432, MAY 25, 2022
  - 🇺🇸 BW = 79 lbs.
- ❖ Through no fault of her own, she didn't calve in 2023.
- ❖ This young heifer has outstanding conformation, she is very deep and demonstrates the thickness from the Gus line.
- ❖ Bred to **Abel G Man 55K CCA 2299594** exposed 62 days

| #  | CED  | BW   | WW   | YW   | RADG  | DMI   | Scrotal | DOC  | Claw  | Angle | CWT  | Marble | REA   | Fat    | HPG  | CEM  | Milk |
|--|------|------|------|------|-------|-------|---------|------|-------|-------|------|--------|-------|--------|------|------|------|
| EPD  | -4.0 | +3.0 | +52  | +94  |       |       |         |      |       |       |      |        |       |        |      | -1.0 | +28  |
| ACC  | 20   | 29   | 23   | 11   |       |       |         |      |       |       |      |        |       |        |      | 6    | 6    |
| Breed Avg (Click for Percentiles)                    |      |      |      |      |       |       |         |      |       |       |      |        |       |        |      |      |      |
| EPD  | +3.3 | +2.0 | +54  | +95  | +0.24 | +0.91 | +0.86   | +18  | +0.44 | +0.45 | +43  | +0.47  | +0.53 | +0.020 | +11  | +6.4 | +23  |
| EPD Percentiles for SELINGER OZS 5K (OZS 5K) 2290432 |      |      |      |      |       |       |         |      |       |       |      |        |       |        |      |      |      |
|  | 93 % | 70 % | 56 % | 52 % | 50 %  | 50 %  | 50 %    | 50 % | 50 %  | 50 %  | 50 % | 50 %   | 50 %  | 50 %   | 50 % | 97 % | 11 % |

**Animal Enquiry**

**Registration No.** SELINGER OZS 5K (OZS 5K) 2290432  
**Rego Status** Registered  
**LE Tattoo**  
**Tattoo** OZS 5K  
**Date of Birth** 25 May 2022  
**Sire** ABEL 1H (ABEL 1H) 2202721  
**Dam** ABEL ESTHER 57H (ABEL 57H) 2203772  
**Recipient Dam**

**Status** Active  
**RE Tattoo** OZS 5K  
**Sex** Female  
**Management Tag** 5K

- Details
- Pedigree**
- Progeny
- EPDs
- Traits
- Ownership
- Breeder

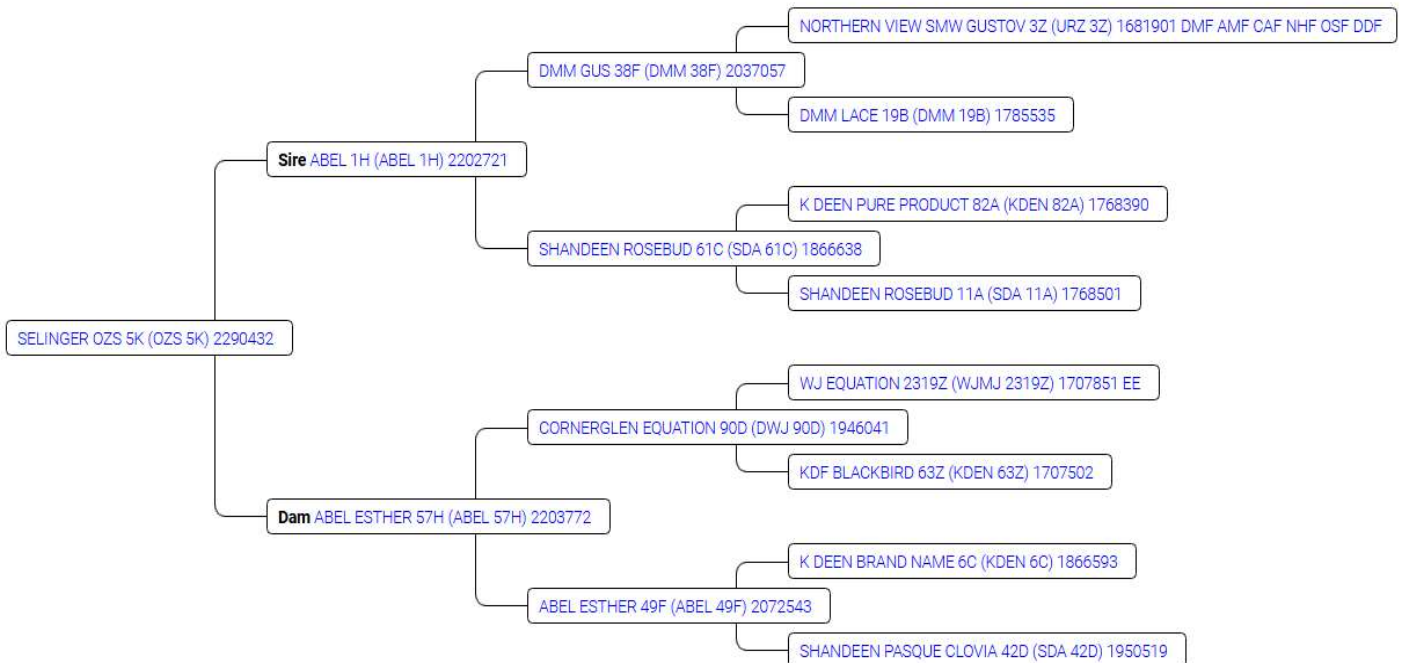

**No. 31**



- ❖ **SELINGER OZS 6K Cow.**
- ❖ **Sired by ABEL 1H (2202721). The son of DMM GUS.**
  - 🇨🇦 CAA No. 2290433, MAY 25, 2022
  - 🇨🇦 BW = 83 lbs.
- ❖ This years calf No. is **OZS BLACKBIRD 61M**
- ❖ This young cow has a great fur coat to withstand the Alberta winters.
- ❖ She comes from an excellent pedigree that shows long thick frames and will provide year-after-year calving results.
- ❖ Bred to **Abel G Man 55K CCA 2299594** exposed 62 days

| #  | CED  | BW   | WW   | YW   | RADG  | DMI   | Scrotal | DOC  | Claw  | Angle | CWT  | Marble | REA   | Fat    | HPG  | CEM   | Milk |
|--|------|------|------|------|-------|-------|---------|------|-------|-------|------|--------|-------|--------|------|-------|------|
| EPD  | -7.0 | +3.8 | +45  | +84  |       |       | +0.91   |      |       |       |      |        |       |        |      | -11.0 | +22  |
| ACC  | 20   | 31   | 22   | 12   |       |       | P       |      |       |       |      |        |       |        |      | 11    | 7    |
| Breed Avg (Click for Percentiles)                    |      |      |      |      |       |       |         |      |       |       |      |        |       |        |      |       |      |
| EPD  | +3.3 | +2.0 | +54  | +95  | +0.24 | +0.91 | +0.86   | +18  | +0.44 | +0.45 | +43  | +0.47  | +0.53 | +0.020 | +11  | +6.4  | +23  |
| EPD Percentiles for SELINGER OZS 6K (OZS 6K) 2290433 |      |      |      |      |       |       |         |      |       |       |      |        |       |        |      |       |      |
|  | 98 % | 85 % | 78 % | 71 % | 50 %  | 50 %  | 45 %    | 50 % | 50 %  | 50 %  | 50 % | 50 %   | 50 %  | 50 %   | 50 % | 100 % | 58 % |

**Animal Enquiry**

**Registration No.** SELINGER OZS 6K (OZS 6K) 2290433  
**Rego Status** Registered  
**LE Tattoo**  
**Tattoo** OZS 6K  
**Date of Birth** 25 May 2022  
**Sire** ABEL 1H (ABEL 1H) 2202721  
**Dam** ABEL 63H (ABEL 63H) 2250541  
**Recipient Dam**

**Status** Active  
**RE Tattoo** OZS 6K  
**Sex** Female  
**Management Tag** 6K

- Details
- Pedigree
- Progeny
- EPDs
- Traits
- Ownership
- Breeder

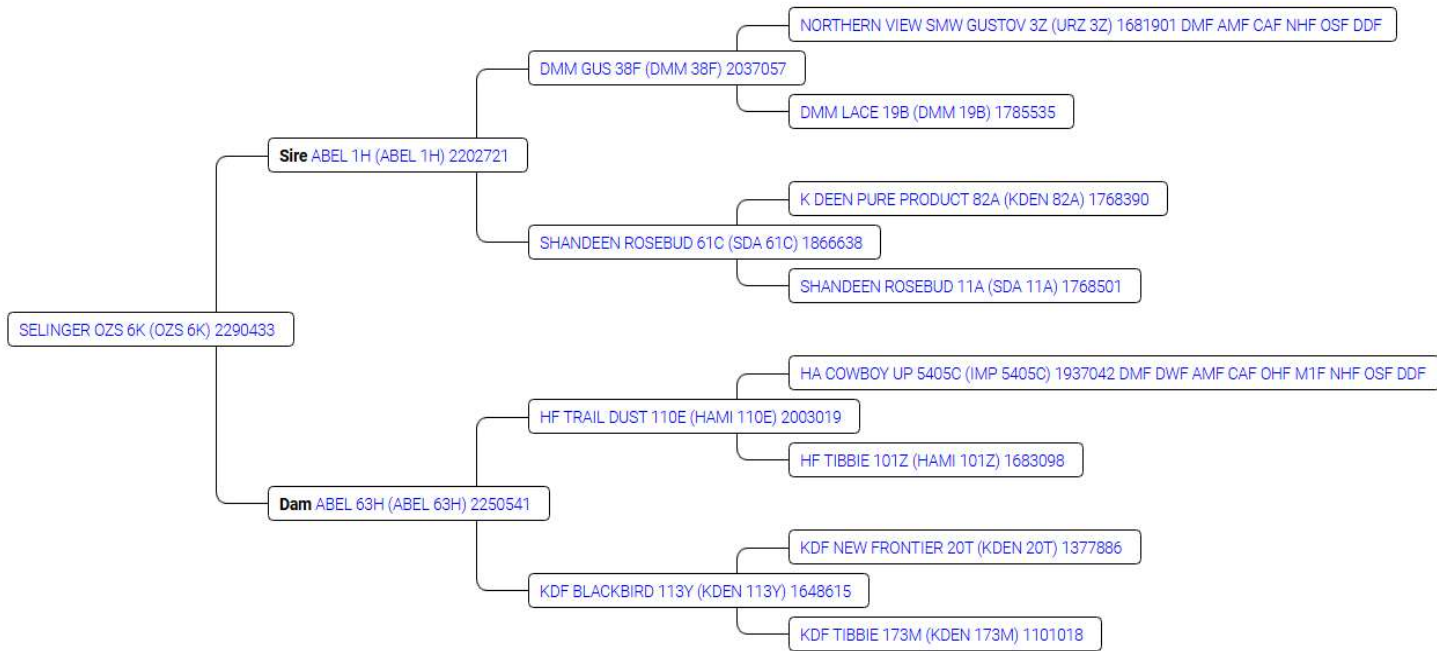





❖ **SELINGER OZS 7K Cow.**  
**Sired by ABEL 1H (2202721).**  
**The son of DMM GUS.**

🇺🇸 CAA No. 2290396, JUNE 7, 2022

🇺🇸 BW = 73 lbs.

- ❖ Through no fault of her own, she didn't calve in 2023.
- ❖ This incredible young cow has outstanding conformation, she is very deep and demonstrates the thickness from the Gus line
- ❖ Bred to **Abel G Man 55K CCA 2299594** exposed 62 days

| #  | CED  | BW   | WW  | YW  | RADG  | DMI   | Scrotal | DOC | Claw  | Angle | CWT | Marble | REA   | Fat    | HPG | CEM  | Milk |
|--|------|------|-----|-----|-------|-------|---------|-----|-------|-------|-----|--------|-------|--------|-----|------|------|
| EPD  | +1.0 | +2.4 | +45 | +82 |       |       |         |     |       |       |     |        |       |        |     | +3.0 | +24  |
| ACC  | P    | P    | P   | P   |       |       |         |     |       |       |     |        |       |        |     | P    | P    |
| Breed Avg (Click for Percentiles)                    |      |      |     |     |       |       |         |     |       |       |     |        |       |        |     |      |      |
| EPD  | +3.3 | +2.0 | +54 | +95 | +0.24 | +0.91 | +0.86   | +18 | +0.44 | +0.45 | +43 | +0.47  | +0.53 | +0.020 | +11 | +6.4 | +23  |
| EPD Percentiles for SELINGER OZS 7K (OZS 7K) 2290396 |      |      |     |     |       |       |         |     |       |       |     |        |       |        |     |      |      |
|  | 66%  | 57%  | 78% | 74% | 50%   | 50%   | 50%     | 50% | 50%   | 50%   | 50% | 50%    | 50%   | 50%    | 50% | 82%  | 39%  |

Animal Enquiry

Registration No. SELINGER OZS 7K (OZS 7K) 2290396  
 Rego Status Registered  
 LE Tattoo  
 Tattoo OZS 7K  
 Date of Birth 07 Jun 2022  
 Sire ABEL 1H (ABEL 1H) 2202721  
 Dam ABEL 19H (ABEL 19H) 2196220  
 Recipient Dam

Status Active  
 RE Tattoo OZS 7K  
 Sex Female  
 Management Tag 7K

- Details
- Pedigree
- Progeny
- EPDs
- Traits
- Ownership
- Breeder

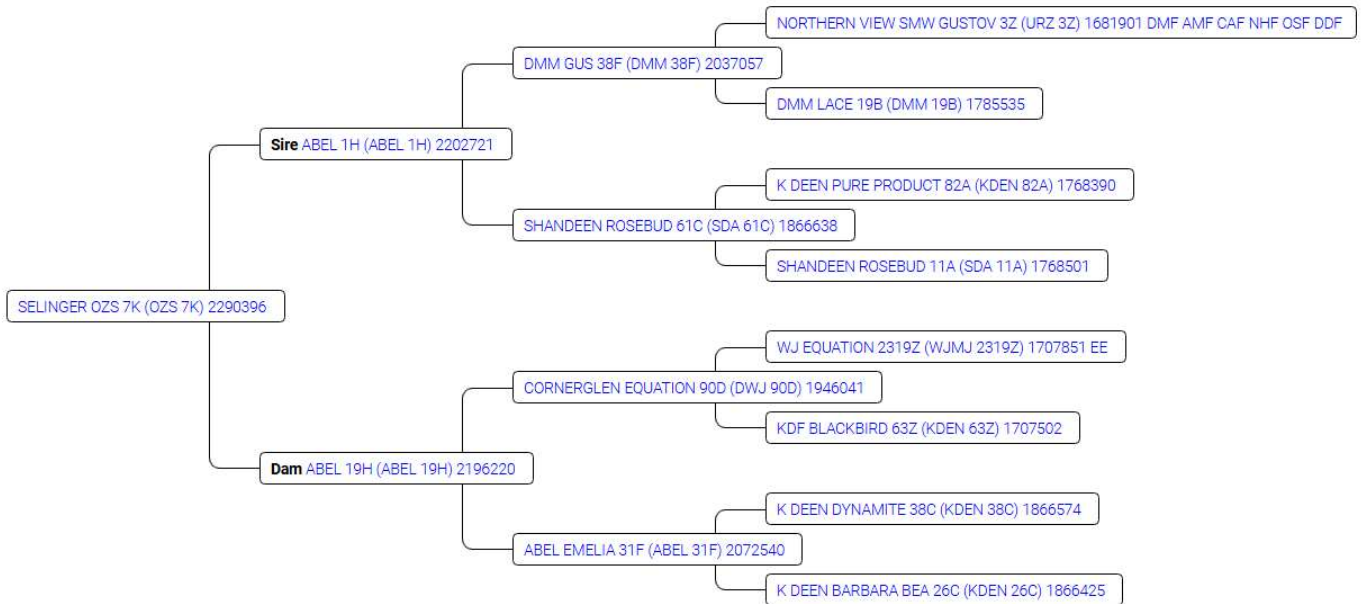



- ❖ K DEEN LAVENDER LADY 39G Cow.
- ❖ Sired by DAMERON C-5 AMERICAN CLASSIC (IMP 1220Z).
  - 🇺🇸 CAA No. 2128799, JAN 31, 2019
  - 🇺🇸 BW = 80 lbs.
- ❖ This cow has outstanding conformation, she is very deep and demonstrates the thickness from Lavender lineage.
- ❖ She has a straight, deep frame with a well-formed udder.
- ❖ She was recently purchased to improve our ranch line.
- ❖ Bred to DMM FIRE 78H, a son of Brooking Firebrand 6068, exposed 62 days

| #  | CED  | BW   | WW  | YW  | RADG  | DMI   | Scrotal | DOC | Claw  | Angle | CWT | Marble | REA   | Fat    | HPG | CEM  | Milk |
|--|------|------|-----|-----|-------|-------|---------|-----|-------|-------|-----|--------|-------|--------|-----|------|------|
| EPD  | -1.0 | +2.1 | +46 | +90 |       |       |         |     |       |       |     |        |       |        |     | -2.0 | +20  |
| ACC  | 21   | 39   | 23  | 19  |       |       |         |     |       |       |     |        |       |        |     | 23   | 19   |
| Breed Avg (Click for Percentiles)                                |      |      |     |     |       |       |         |     |       |       |     |        |       |        |     |      |      |
| EPD  | +3.3 | +2.0 | +54 | +95 | +0.24 | +0.91 | +0.86   | +18 | +0.44 | +0.45 | +43 | +0.47  | +0.53 | +0.020 | +11 | +6.4 | +23  |
| EPD Percentiles for K DEEN LAVENDER LADY 39G (K DEN 39G) 2128799 |      |      |     |     |       |       |         |     |       |       |     |        |       |        |     |      |      |
|  | 80%  | 50%  | 75% | 60% | 50%   | 50%   | 50%     | 50% | 50%   | 50%   | 50% | 50%    | 50%   | 50%    | 50% | 98%  | 76%  |

Animal Enquiry

**Registration No.** K DEEN LAVENDER LADY 39G (K DEN 39G) 2128799  
**Rego Status** Registered  
**LE Tattoo**  
**Tattoo** K DEN 39G  
**Date of Birth** 31 Jan 2019  
**Sire** DAMERON C-5 AMERICAN CLASSIC (IMP 1220Z) 1820769 DMF DWF AMF CAF M1F NHF OSF DDF  
**Dam** K DEEN LAVENDER 95D (K DEN 95D) 1950308  
**Recipient Dam**

**Status** Active  
**RE Tattoo** K DEN 39G  
**Sex** Female  
**Management Tag** 39G

- Details
- Pedigree
- Progeny
- EPDs
- Traits
- Ownership
- Breeder

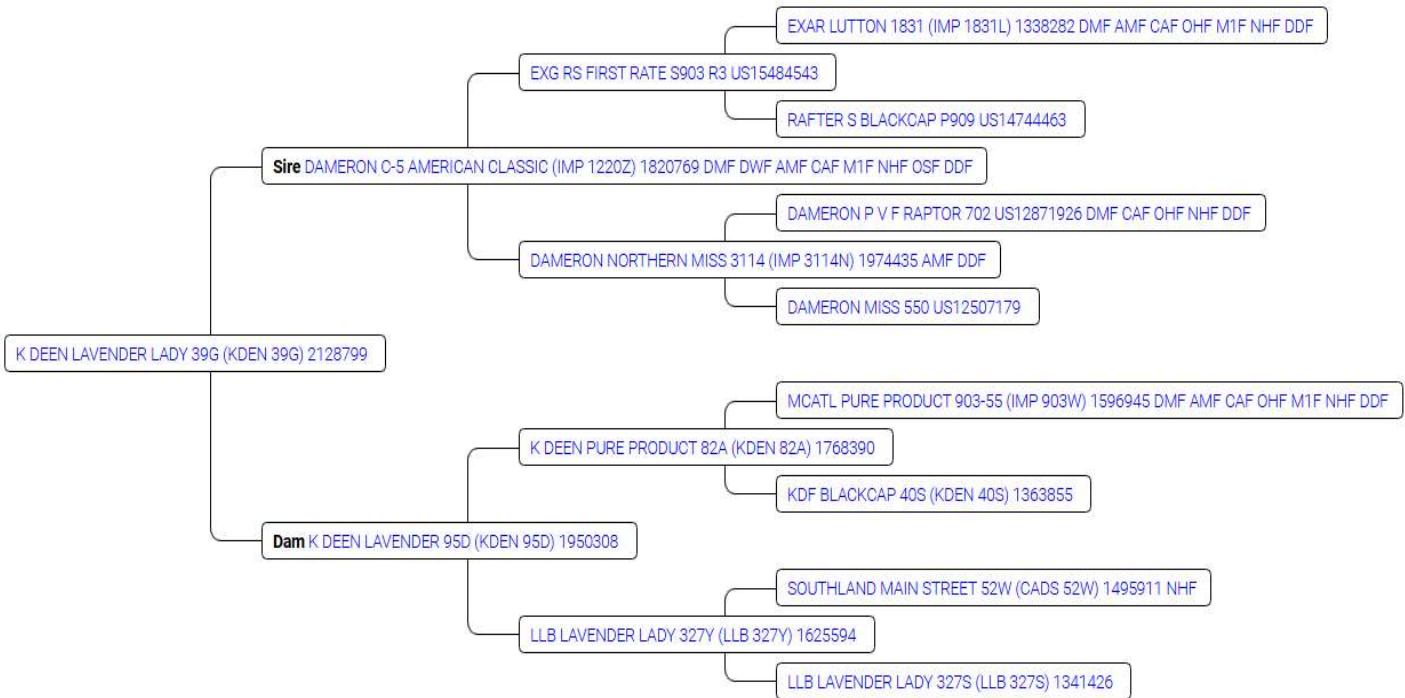



- ❖ K DEEN HEATHER 93G Cow.
- ❖ Sired by BANDURA MR. JET STREAM 92E.

🇺🇸 CAA No. 2176043,  
MARCH 05, 2019

🇺🇸 BW = 86 lbs.

- ❖ This stunning cows lineage has Jet Stream and Heather bloodlines.
- ❖ She was recently purchased to add to our ranch line.
- ❖ Bred to DMM FIRE 78H, a son of Brooking Firebrand 6068, exposed 62 days

| #  | CED  | BW   | WW   | YW   | RADG  | DMI   | Scrotal | DOC  | Claw  | Angle | CWT  | Marble | REA   | Fat    | HPG  | CEM   | Milk |
|--|------|------|------|------|-------|-------|---------|------|-------|-------|------|--------|-------|--------|------|-------|------|
| EPD  | -7.0 | +2.6 | +52  | +88  |       |       |         |      |       |       |      |        |       |        |      | -7.0  | +26  |
| ACC  | 26   | 38   | 20   | 16   |       |       |         |      |       |       |      |        |       |        |      | 20    | 14   |
| Breed Avg (Click for Percentiles)                          |      |      |      |      |       |       |         |      |       |       |      |        |       |        |      |       |      |
| EPD  | +3.3 | +2.0 | +54  | +95  | +0.24 | +0.91 | +0.86   | +18  | +0.44 | +0.45 | +43  | +0.47  | +0.53 | +0.020 | +11  | +6.4  | +23  |
| EPD Percentiles for K DEEN HEATHER 93G (K DEN 93G) 2176043 |      |      |      |      |       |       |         |      |       |       |      |        |       |        |      |       |      |
|  | 98 % | 61 % | 56 % | 64 % | 50 %  | 50 %  | 50 %    | 50 % | 50 %  | 50 %  | 50 % | 50 %   | 50 %  | 50 %   | 50 % | 100 % | 22 % |

Animal Enquiry

Registration No. K DEEN HEATHER 93G (K DEN 93G) 2176043  
 Rego Status Registered  
 LE Tattoo  
 Tattoo K DEN 93G  
 Date of Birth 05 Mar 2019  
 Sire BANDURA MR. JET STREAM 92E (BAN 92E) 1966245  
 Dam K DEEN HEATHER 52E (K DEN 52E) 2011107  
 Recipient Dam

Status Active  
 RE Tattoo K DEN 93G  
 Sex Female  
 Management Tag 93G

|         |          |         |      |        |           |         |
|---------|----------|---------|------|--------|-----------|---------|
| Details | Pedigree | Progeny | EPDs | Traits | Ownership | Breeder |
|---------|----------|---------|------|--------|-----------|---------|

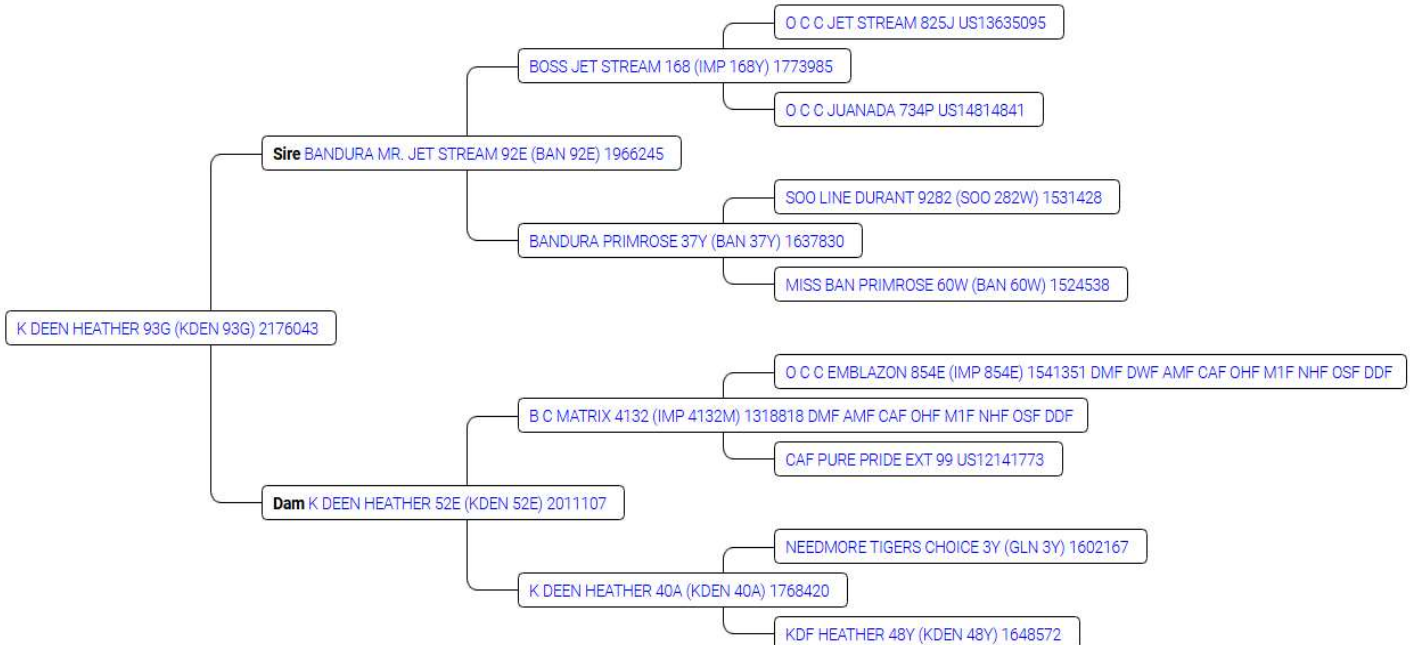

**No. 35**



- ❖ **ABEL 8H Cow.**
- ❖ **Sired by DMM GUS 38F (2037057).**
  - 🇺🇸 CAA No. 2202722, APRIL 21, 2020
  - 🇺🇸 BW = 89 lbs.
- ❖ This cow lineage has Gus on the top side and Blackcap on the bottom side.
- ❖ Another outstanding temperament. With good udder and feet.
- ❖ Bred to **DMM FIRE 78H**, a son of **Brooking Firebrand 6068**, exposed 62 days ✓

| #  | CED  | BW   | WW   | YW   | RADG  | DMI   | Scrotal | DOC  | Claw  | Angle | CWT  | Marble | REA   | Fat    | HPG  | CEM  | Milk |
|--|------|------|------|------|-------|-------|---------|------|-------|-------|------|--------|-------|--------|------|------|------|
| EPD  | -8.0 | +5.2 | +40  | +72  |       |       |         |      | +0.41 | +0.43 |      |        |       |        | +10  | +1.0 | +22  |
| ACC  | 17   | 37   | 31   | 24   |       |       |         |      | 14    | 16    |      |        |       |        | 12   | 14   | 21   |
| <b>Breed Avg (Click for Percentiles)</b>             |      |      |      |      |       |       |         |      |       |       |      |        |       |        |      |      |      |
| EPD  | +3.3 | +2.0 | +54  | +95  | +0.24 | +0.91 | +0.86   | +18  | +0.44 | +0.45 | +43  | +0.47  | +0.53 | +0.020 | +11  | +6.4 | +23  |
| <b>EPD Percentiles for ABEL 8H (ABEL 8H) 2202722</b> |      |      |      |      |       |       |         |      |       |       |      |        |       |        |      |      |      |
|  | 99 % | 97 % | 88 % | 87 % | 50 %  | 50 %  | 50 %    | 50 % | 34 %  | 36 %  | 50 % | 50 %   | 50 %  | 50 %   | 62 % | 92 % | 58 % |

**Animal Enquiry**

**Registration No.** ABEL 8H (ABEL 8H) 2202722  
**Rego Status** Registered  
**LE Tattoo**  
**Tattoo** ABEL 8H  
**Date of Birth** 21 Apr 2020  
**Sire** DMM GUS 38F (DMM 38F) 2037057  
**Dam** KDF BLACKCAP 115Y (KDEN 115Y) 1648586  
**Recipient Dam**

- Details
- Pedigree
- Progeny
- EPDs
- Traits
- Ownership
- Breeder

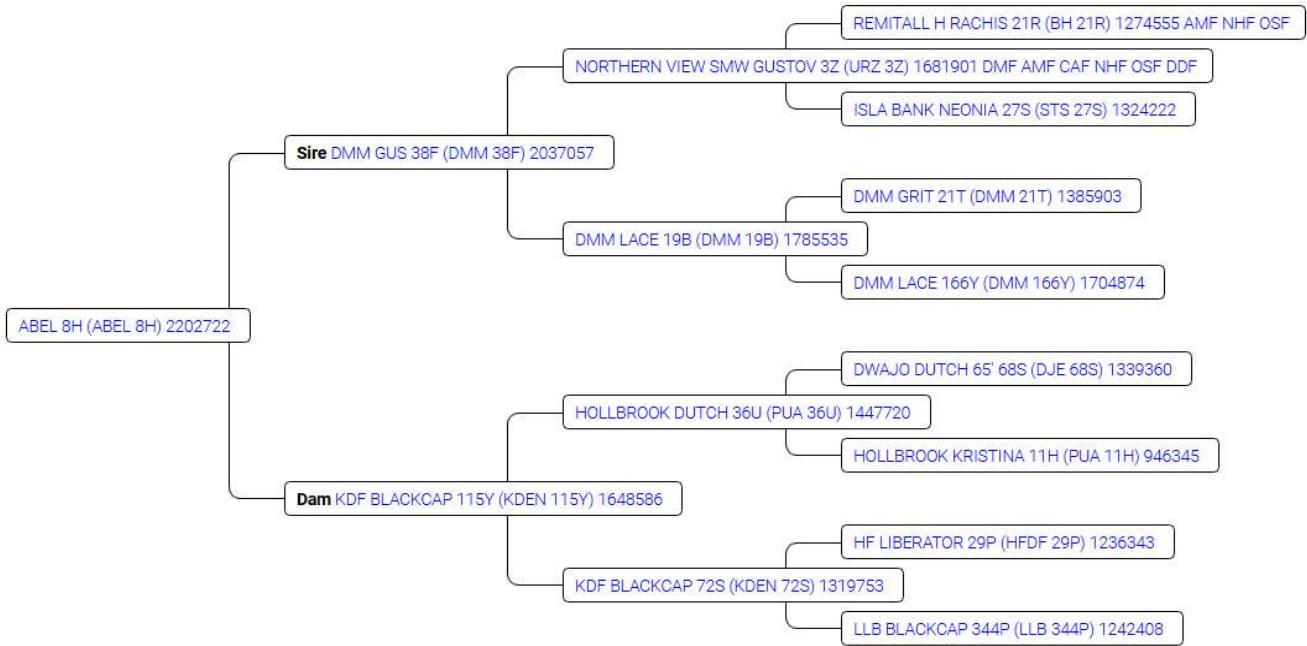

No. 36



❖ **ABEL 6H Cow.**

Sire **UNKNOWN.**

📅 BD = MAY 01, 2020

📏 BW = 80 lbs.

- ❖ This cow consistently produces excellent calves with great growth.
- ❖ With no exception this has great udder and feet. She throws these amazing traits.
- ❖ Known bottom genetic line stems from the lineage of Tibbie.
- ❖ Bred to **DMM FIRE 78H**, a son of **Brooking Firebrand 6068**, exposed 62 days✓

| #   | CED        | BW      | WW | YW | MIK |
|-----|------------|---------|----|----|-----|
| EPD | -          | 80 lbs. | -  | -  | -   |
| ACC | -          | -       | -  | -  | -   |
| EPD | -          | -       | -  | -  | -   |
| BD  | 05/01/2020 |         |    |    |     |

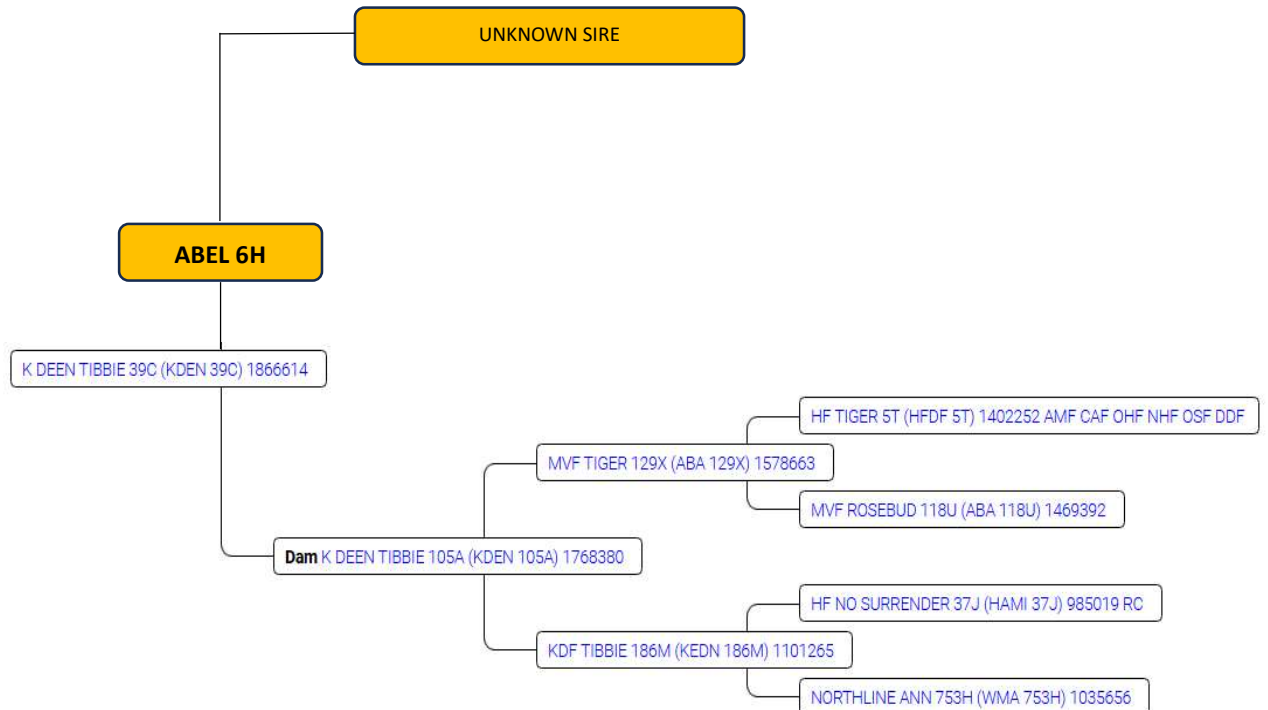

No. 37



| #   | CED        | BW      | WW | YW | MIK |
|-----|------------|---------|----|----|-----|
| EPD | -          | 78 lbs. | -  | -  | -   |
| ACC | -          | -       | -  | -  | -   |
| EPD | -          | -       | -  | -  | -   |
| BD  | 05/10/2020 |         |    |    |     |

❖ **ABEL 23H Cow, sire is UNKNOWN.**

📅 BD = MAY 10, 2020

📅 BW = 78 lbs.

- ❖ This is a well-built LONG FRAMED COW, would be a great addition to your herd.
- ❖ Great udder and feet.
- ❖ This a sweet easy-going cow that produces calves with high daily gain rate.
- ❖ Bred to **DMM FIRE 78H**, a son of **Brooking Firebrand 6068**, exposed 62 days



| #   | CED        | BW      | WW | YW | MIK |
|-----|------------|---------|----|----|-----|
| EPD | -          | 75 lbs. | -  | -  | -   |
| ACC | -          | -       | -  | -  | -   |
| EPD | -          | -       | -  | -  | -   |
| BD  | 05/06/2019 |         |    |    |     |

- ❖ **SELINGER OZS 80G COMMERCIAL Cow.**
- ❖ **Sired by ABEL 1H (2202721). The son of DMM GUS.**
  - 📅 BD = MAY 06, 2019
  - 📅 BW = 75 lbs.
- ❖ This is a well-built LONG FRAMED COW, would be a great addition to your herd.
- ❖ The Dam side has incredible feet, udder and maternal characteristics.
- ❖ We had her dam for 18 years and she produced large healthy calves all of those years
- ❖ Bred to **DMM FIRE 78H**, a son of **Brooking Firebrand 6068**, exposed 62 days ✓

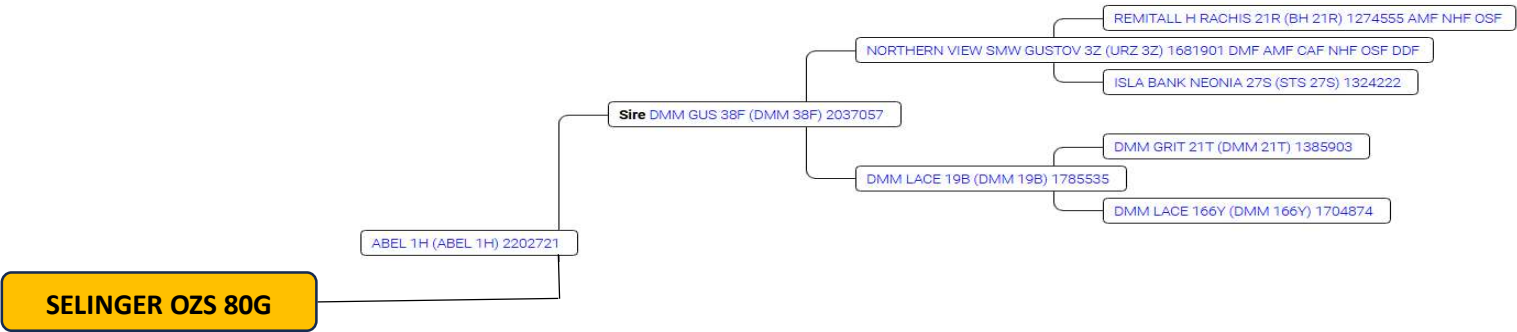



| #   | CED        | BW      | WW | YW | MIK |
|-----|------------|---------|----|----|-----|
| EPD | -          | 85 lbs. | -  | -  | -   |
| ACC | -          | -       | -  | -  | -   |
| EPD | -          | -       | -  | -  | -   |
| BD  | 03/15/2018 |         |    |    |     |

❖ **ACR 81F COMMERCIAL Cow.**

❖ **Sire UNKNOWN.**

📅 BD = MARCH 15, 2018

📅 BW = 85 lbs.

- ❖ This is a well-built LONG FRAMED COW, would be a great addition to your herd.
- ❖ This cow is our herds lead cow and she's a great leader.
- ❖ Raises a good-sized calf year after year.
- ❖ Bred to **DMM FIRE 78H**, a son of **Brooking Firebrand 6068**, exposed 62 days



**No. 40**



- ❖ **ACR 82J COMMERCIAL Cow.**
- ❖ **Sire UNKNOWN. Angle Creek Ranch.**
  - 📅 BD = June 16, 2021
  - 📅 BW = 80 lbs.
- ❖ This cow will allow other calves to nurse, would be a great addition to your herd.
- ❖ Great maternal instincts.
- ❖ Produces an outstanding calf as shown in the picture below.
- ❖ Bred to **DMM FIRE 78H**, a son of **Brooking Firebrand 6068**, exposed 62 days✓

| #   | CED        | BW      | WW | YW | MIK |
|-----|------------|---------|----|----|-----|
| EPD | -          | 80 lbs. | -  | -  | -   |
| ACC | -          | -       | -  | -  | -   |
| EPD | -          | -       | -  | -  | -   |
| BD  | 06/15/2021 |         |    |    |     |

**No. 41**



- ❖ **SELINGER OZS 3K COMMERCIAL Cow.**
- ❖ **Sired by ABEL 1H (2202721). The son of DMM GUS.**
  - ⚡ BD = APRIL 28, 2024
  - ⚡ BW = 83 lbs.
- ❖ Dam is ABEL 23H
- ❖ This cow will mirror her dam, yielding good calves, easy to work with good temperaments.
- ❖ This cow will produce some great G-Man calves.
- ❖ Bred to **Abel G Man 55K CCA 2299594** exposed 62 days ✓

| #   | CED        | BW      | WW | YW | MIK |
|-----|------------|---------|----|----|-----|
| EPD | -          | 83 lbs. | -  | -  | -   |
| ACC | -          | -       | -  | -  | -   |
| EPD | -          | -       | -  | -  | -   |
| BD  | 04/28/2022 |         |    |    |     |

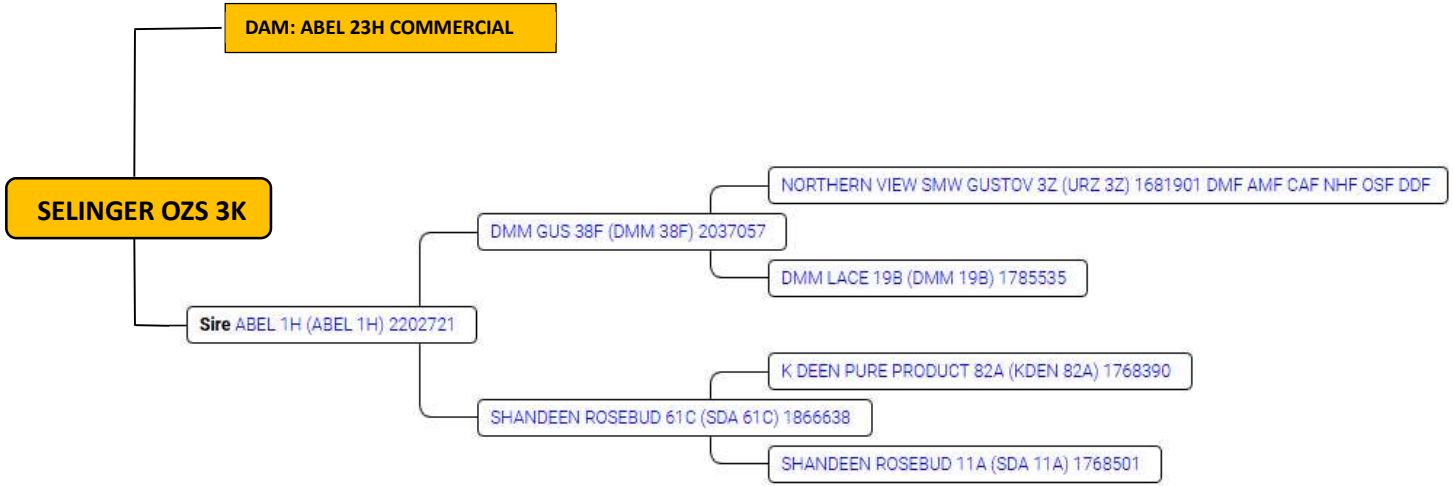

No. 42



- ❖ **SELINGER OZS 10K COMMERCIAL Cow.**
- ❖ **Sired by ABEL 1H (2202721). The son of DMM GUS.**
  - 📅 BD = AUG 16, 2022
  - 📅 BW = 85 lbs.
- ❖ The top side of this cow's lineage is the bull Gus, known for his great size, length, and depth. We have carried the Gus line for years.
- ❖ DAM side is ABEL 6H, having a good feet and udder.
- ❖ Bred to **Abel G Man 55K CCA 2299594** exposed 62 days

| #   | CED        | BW     | WW | YW | MIK |
|-----|------------|--------|----|----|-----|
| EPD | -          | 85lbs. | -  | -  | -   |
| ACC | -          | -      | -  | -  | -   |
| EPD | -          | -      | -  | -  | -   |
| BD  | 08/16/2022 |        |    |    |     |

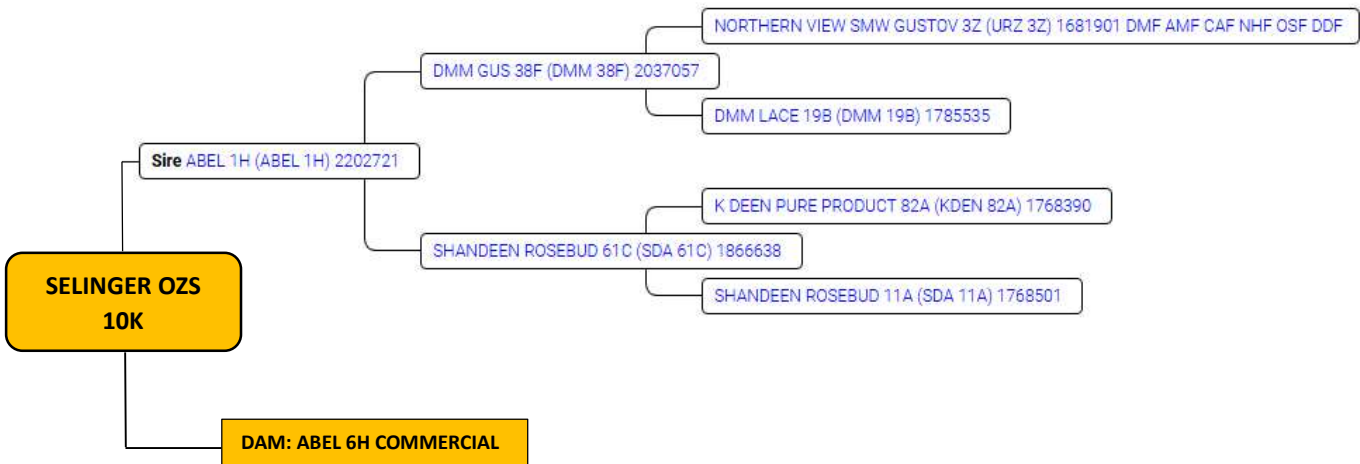

**No. 43**



- ❖ **OZS 80L Commercial Bull, sired is ABEL 1H (2202721). The son of DMM GUS.**
- ❖ we have had this commercial line for +20 yrs.
  - ✚ BD = MAY 09, 2023
  - ✚ BW = 112 lbs.
- ❖ This bull is very quiet, and will put lots of performance growth into his calves.
- ❖ The Dam lineage showed above average conformation at 18 years of age.
- ❖ Dam had incredible feet, udder and maternal characteristics.
- ❖ This has been a top selling bull line for us year after year.
- ❖ Tested and proven, field ready.

| #   | CED        | BW       | WW       | YW | SCTOTAL |
|-----|------------|----------|----------|----|---------|
| EPD | -          | 112 lbs. | 695 lbs. | -  | 36 cm   |
| ACC | -          |          | -        | -  |         |
| EPD | -          |          | -        | -  |         |
| BD  | 05/09/2023 |          |          |    |         |

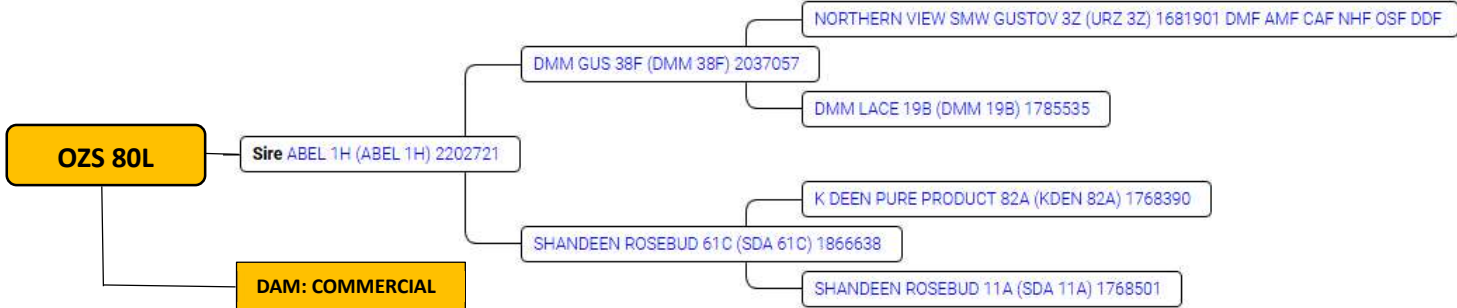



❖ **DMM FIRE 78H is the son of the 2024 Reserve World Grand Champion Bull Brooking Firebrand 6068.**

🇺🇸 CAA No. 2139847, FEB 09, 2020

🇺🇸 BW = 89 lbs.

- ❖ This is a chance to invest in a top-tier bloodline. **The son of the 2024 Reserve Grand Champion Brooking Firebrand 6068**, awarded at the Palermo show in Argentina.
- ❖ He is powerful in every dimension and demands your attention with this thickness, length, great muscle expression. Has great feet and the most gentle disposition we've ever seen.
- ❖ This bull is extremely quiet and easy to handle.
- ❖ His heifer calves equal the size of his bull calves.
- ❖ A tested and proven opportunity to introduce world class blood lines into your herd.
- ❖ Best bull we have had in 33 years of operation.

| World Angus Evaluation August 2024 Black Angus   |              |              |                |                 |       |       |               |          |       |       |                |          |       |        |     |                  |      |               |               |      |
|--|--------------|--------------|----------------|-----------------|-------|-------|---------------|----------|-------|-------|----------------|----------|-------|--------|-----|------------------|------|---------------|---------------|------|
|  | Calving Ease | Birth Weight | Weaning Weight | Yearling Weight | RADG  | DMI   | Scrotal Circ. | Docility | Claw  | Angle | Carcass Weight | Marbling | REA   | Fat    | HPG | Mat Calving Ease | Milk | Mature Weight | Mature Height | CBI  |
| EPD  | -8.0         | +5.2         | +60            | +96             | +0.20 | +0.43 | +0.95         | +14      | +0.34 | +0.41 | +32            | -0.12    | +0.72 | -0.005 | +5  | +2.0             | +23  | +35           | +0.3          | -    |
| Accuracy   | 28           | 55           | 27             | 24              | P     | P     | P             | P        | P     | P     | P              | P        | P     | P      | P   | 22               | 21   | P             | P             | -    |
| TOP %  | 98           | 96           | 30             | 45              | 85    | 15    | 40            | 70       | 9     | 25    | 80             | 99       | 20    | 15     | 97  | 92               | 55   | 80            | 60            | -    |
| Average EPDs for all Black Calves born in 2023 <a href="#">Click for Percentiles</a>               |              |              |                |                 |       |       |               |          |       |       |                |          |       |        |     |                  |      |               |               |      |
| Average EPDs for all Red and Red Carrier Calves born in 2023 <a href="#">Click for Percentiles</a> |              |              |                |                 |       |       |               |          |       |       |                |          |       |        |     |                  |      |               |               |      |
| EPD  | +3.3         | +2.0         | +54            | +95             | +0.24 | +0.91 | +0.85         | +18      | +0.44 | +0.45 | +43            | +0.47    | +0.53 | +0.021 | +11 | +6.6             | +23  | +61           | +0.4          | +285 |
|  | +2.3         | +1.3         | +43            | +74             | +0.19 | +0.38 | +0.76         | +14      | +0.43 | +0.48 | +25            | +0.23    | +0.40 | -0.004 | +10 | +5.4             | +25  | +44           | +0.3          | +227 |

## Animal Enquiry

Registration No. DMM FIRE 78H (DMM 78H) 2139847  
 Rego Status Registered  
 LE Tattoo  
 Tattoo DMM 78H  
 Date of Birth 09 Feb 2020  
 Sire BROOKING FIREBRAND 6068 (JSTN 68D) 1906246 DMF  
 Dam DMM BLACKBIRD 105A (DMM 105A) 1765827  
 Recipient Dam

|         |                 |         |      |        |           |         |
|---------|-----------------|---------|------|--------|-----------|---------|
| Details | <b>Pedigree</b> | Progeny | EPDs | Traits | Ownership | Breeder |
|---------|-----------------|---------|------|--------|-----------|---------|

